



J-FET INPUT OPERATIONAL AMPLIFIER

■ GENERAL DESCRIPTION

The NJM062/064 are J-FET input operational amplifiers which were designed as low-power versions of the NJM082. They feature high input impedance, wide bandwidth, high slew rate, and low input offset and bias current. The NJM062 features the same terminal assignments as the NJM4558/2043/2904/3404/072 and NJM064 features the same terminal assignments as the NJM2902/3403/2058/2059/2060. Each of these JFET-input operational amplifiers incorporates well-matched, high voltage JFET and bipolar transistors in a monolithic integrated circuit.

■ FEATURES

- Operating Voltage (±2V ~ ±18V)
- J-FET Input
- High Input Resistance (10<sup>12</sup>Ω typ.)
- Low Operating Current (200 μA/circuit typ.)
- High Slew Rate (3.5V/μs typ.)
- Wide Unity Gain Bandwidth (1MHz typ.)
- Package Outline DIP8/14, DMP8/14, SSOP8/14, SIP8
- Bipolar Technology

■ PACKAGE OUTLINE

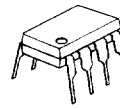

NJM082D



NJM082M

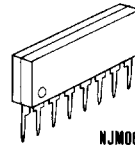

NJM082L



NJM082V

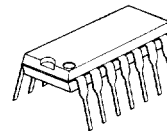

NJM064D

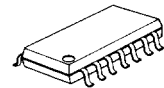

NJM064M

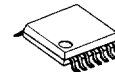

NJM064V

■ PIN CONFIGURATION

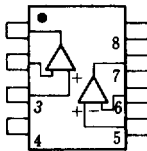

NJM082D  
NJM082M  
NJM082V

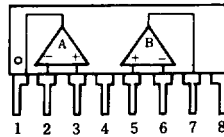

NJM082L

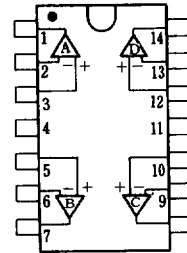

NJM064D  
NJM064M  
NJM064V

PIN FUNCTION

1. A OUTPUT
2. A-INPUT
3. A+INPUT
4. V+
5. B+INPUT
6. B-INPUT
7. B OUTPUT
8. C OUTPUT
9. C-INPUT
10. C+INPUT
11. V-
12. D+INPUT
13. D-INPUT
14. D OUTPUT

PIN FUNCTION

1. A OUTPUT
2. A-INPUT
3. A+INPUT
4. V-
5. B+INPUT
6. B-INPUT
7. B OUTPUT
8. V+



■ EQUIVALENT CIRCUIT

(062 is 1/2 Shown. 064 is 1/4 Shown)

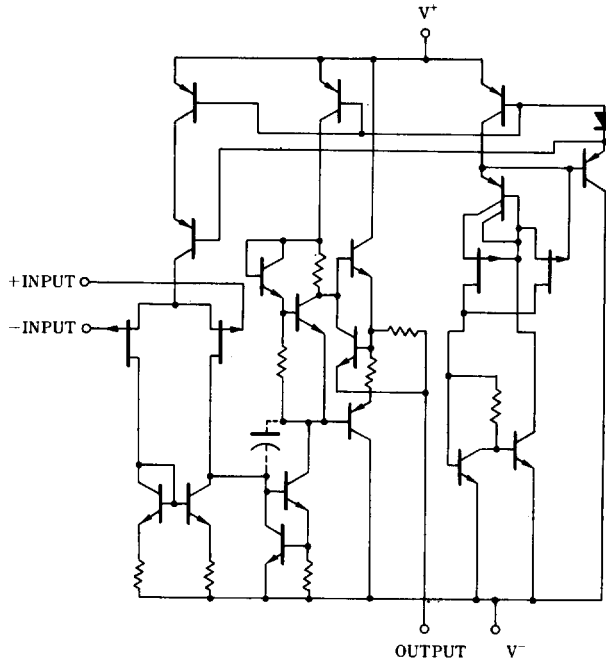

4



## ■ ABSOLUTE MAXIMUM RATINGS

(Ta=25°C)

PARAMETER	SYMBOL	RATINGS	UNIT
Supply Voltage	V <sup>+</sup> /V <sup>-</sup>	±18	V
Differential Input Voltage	V <sub>ID</sub>	±30	V
Input Voltage	V <sub>I</sub>	±15	V
Power Dissipation	P <sub>D</sub>	(DIP8) 500	mW
		(DMP8) 300	mW
		(SIP8) 800	mW
		(SSOP8) 250	mW
		(DIP14) 700	mW
		(DMP14) 700 (note 2)	mW
	(SSOP14) 300	mW	
Operating Temperature Range	T <sub>opr</sub>	-20~+75	°C
Storage Temperature Range	T <sub>stg</sub>	-40~+125	°C

(note 1) For supply voltage less than ±15V, the absolute maximum input voltage is equal to the supply voltage.  
 (note 2) at on PC board

## ■ ELECTRICAL CHARACTERISTICS (V<sup>+</sup>/V<sup>-</sup>=±15V, Ta=25°C)

PARAMETER	SYMBOL	TEST CONDITION	MIN.	TYP.	MAX.	UNIT
Operating Supply Voltage	V <sup>+</sup> /V <sup>-</sup>		±2	—	±18	V
Input Offset Voltage	V <sub>IO</sub>	R <sub>S</sub> = 50Ω	—	3	15	mV
Input Offset Current	I <sub>IO</sub>		—	1	200	pA
Input Bias Current	I <sub>B</sub>		—	2	400	pA
Input Common Mode voltage Range	V <sub>ICM</sub>		±13	+15	—	V
Maximum Peak-to-peak Output Voltage Swing	V <sub>OM</sub>	R <sub>L</sub> = 10kΩ	±13	+13.5	—	V
Large-signal Voltage Gain	A <sub>V</sub>	R <sub>L</sub> ≥ 10kΩ, V <sub>O</sub> = ±10V	70	80	—	dB
Unity Gain Bandwidth	f <sub>T</sub>	R <sub>L</sub> = 10kΩ	—	1	—	MHz
Input Resistance	R <sub>IN</sub>		—	10 <sup>12</sup>	—	Ω
Common Mode Rejection Ratio	CMR	R <sub>S</sub> ≤ 10kΩ	70	90	—	dB
Supply voltage Rejection Ratio	SVR	R <sub>S</sub> ≤ 10kΩ	70	100	—	dB
Operating Current	I <sub>CC</sub>	R <sub>L</sub> = ∞ each amplifier	—	200	250	μA
Slew Rate	SR	R <sub>L</sub> = 10kΩ	—	3.5	—	V/μs
Equivalent Input Noise Voltage	e <sub>n</sub>	R <sub>S</sub> = 100Ω, f = 1kHz	—	35	—	nV/√Hz



■ TYPICAL CHARACTERISTICS

**Voltage Gain, Phase Shift vs. Frequency**

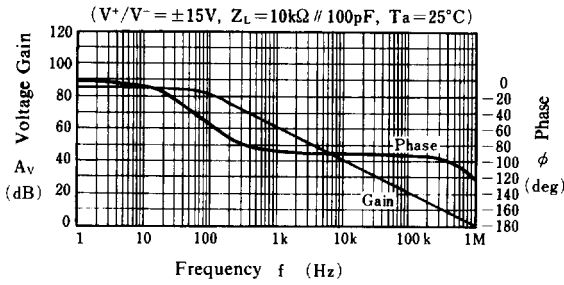

**Maximum Output Voltage Swing vs. Frequency**

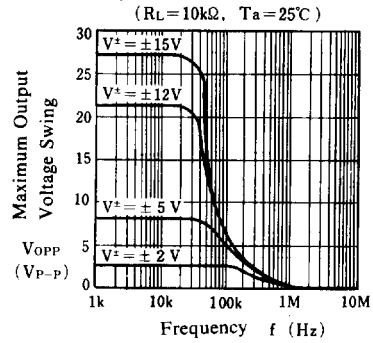

**Maximum Output Voltage Swing vs. Load Resistance**

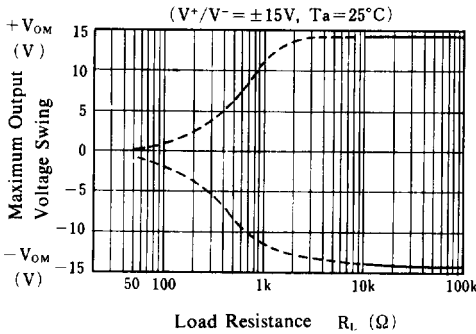

**Maximum Output Voltage Swing vs. Output Current**

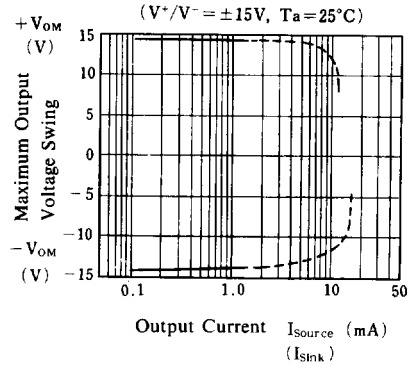

**Equivalent Input Noise Voltage vs. Frequency**

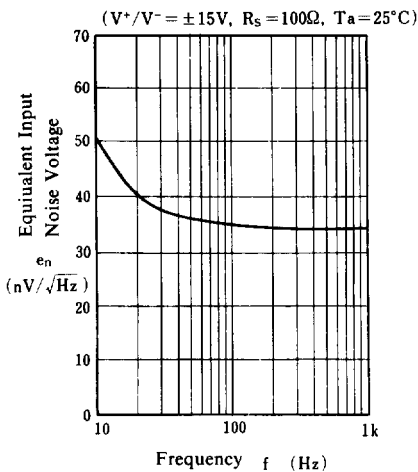

**Voltage Follower Large Signal Pulse Response**

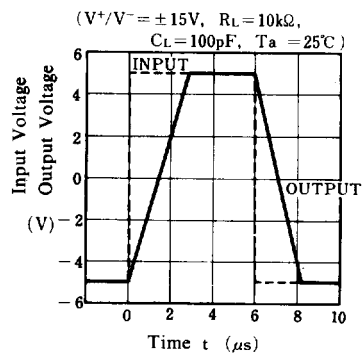

4



## TYPICAL CHARACTERISTICS

### Operating Current vs. Temperature

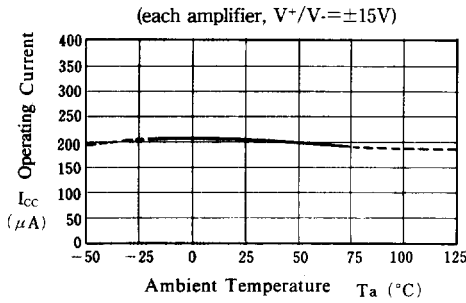

### Maximum Output Voltage Swing vs. Temperature

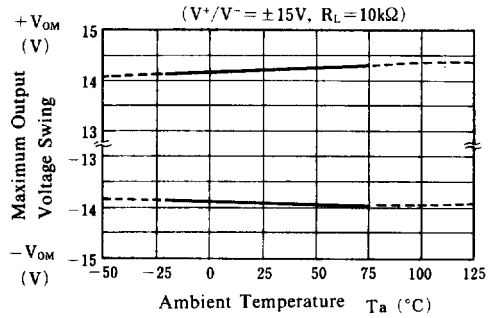

### Input Offset Voltage vs. Temperature

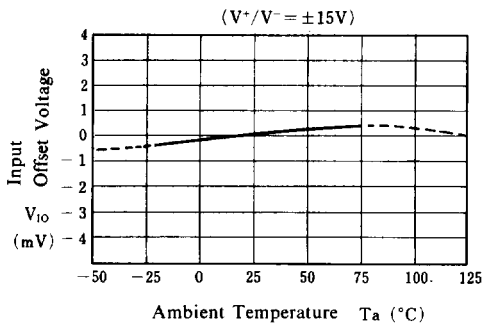

### Input Bias Current vs. Temperature

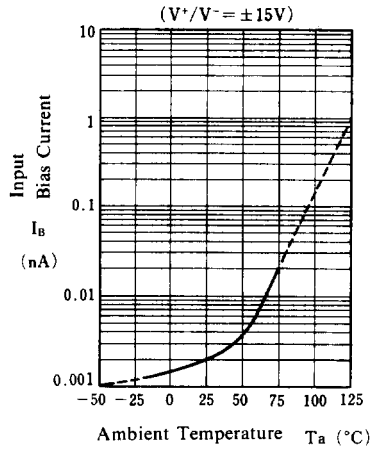

### Maximum Output Voltage Swing vs. Operating Voltage

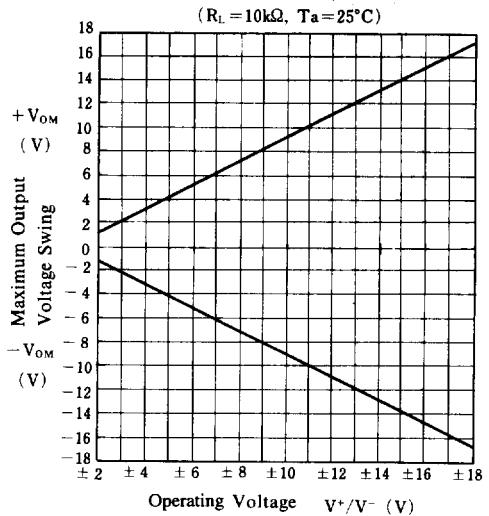

### Operating Current vs. Operating Voltage

