

# AM/FM 1-CHIP RADIO

KA22427B is a monolithic integrated circuit designed for the portable AM/FM radio or AM/FM clock radios.

16-DIP-300A

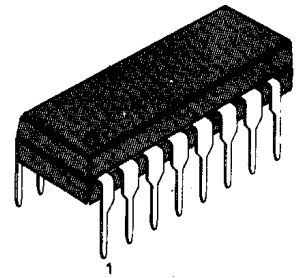

## FUNCTIONS

- AM RF & MIX
- AM AGC
- AM/FM DET
- Regulator
- AM Local OSC
- AM/FM IF AMP
- Audio Power AMP
- FM AFC Control

## FEATURE

- Portable AM/FM 1-chip radio
- Wide operating supply voltage range:  $V_{CC} = 3V \sim 12V$  (Approximately) (Depending on the internal regulator tolerance)
- Recommended operating supply voltage:  $V_{CC} = 4.5V \sim 9V$

## ORDERING INFORMATION

Device	Package	Operating Temperature
KA22427B	16-DIP-300A	-20°C~+70°C

$R_L$ \ $V_{CC}$	4.5V	6.0V	7.5V	9.0V	Line Operated
8Ω	○	○	○	X	X
16Ω	○	○	○	○	X
45Ω	○	○	○	○	○

- On using AC line as an internal shunt regulator mode, it is possible to use low cost application without a transformer (approximately 42mA)
- IF AMP gain is determined by DC voltage appeared at IC Pin 16.
- Power output:  $P_o = 0.28W$  (Min.) at THD = 10% ( $V_{CC} = 5.5V/8Ω$ ).

## BLOCK DIAGRAM

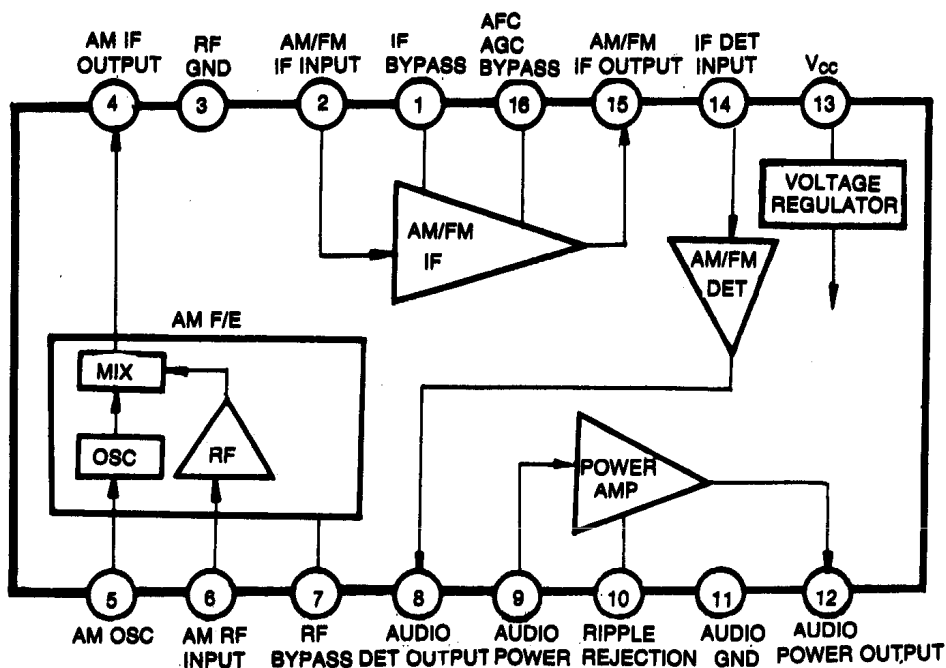

**ABSOLUTE MAXIMUM RATINGS (Ta = 25°C)**

Characteristic	Symbol	Value	Unit
Supply Voltage	V <sub>CC</sub>	13	V
Power Dissipation (Note) Ta ≤ 65°C	P <sub>D</sub>	600	mW
Supply Current	I <sub>CC</sub>	44	mA
Thermal Resistance Junction to Ambient	R <sub>eJA</sub>	100	°C/W
Operating Temperature	T <sub>OPR</sub>	-20 ~ +70	°C
Storage Temperature	T <sub>STG</sub>	-55 ~ +150	°C

**ELECTRICAL CHARACTERISTICS**(Ta = 25°C, V<sub>CC</sub> = 5.5V, f<sub>m</sub> = 1KHz, AM: f = 1MHz, 30% Mod, FM: f = 10.7MHz

Δf = 22.5KHz, Unless otherwise specified)

Characteristic		Symbol	Test Conditions	Min	Typ	Max	Unit
FM	Quiescent Circuit Current	I <sub>CCQ</sub>	SW: FM, V <sub>CC</sub> = 3V	10	15	20	mA
			SW: FM, V <sub>CC</sub> = 9V	13	20	26	
	Pin 16 Terminal Voltage	V <sub>16</sub> (FM)	SW: FM, V <sub>CC</sub> = 9V, V <sub>I</sub> = 0	2.0	2.4	3.1	V
	-3dB Limiting Sensitivity	V <sub>I(LIM)</sub>	SW: FM, -3dB V <sub>16</sub> = 2.4V, V <sub>R</sub> Min		57		dBμ
AM	Internal Regulated Vtg.	V <sub>CC</sub>	SW: AM, I <sub>CC</sub> = 42mA	12	13.2	14.0	V
	Pin 16 Voltage	V <sub>16</sub> (AM)	SW: AM, V <sub>CC</sub> = 9V, V <sub>I</sub> = 0	1.4		1.9	V
	Maximum Sensitivity	S <sub>MAX</sub>	SW: AM, V <sub>CC</sub> = 12V V <sub>I</sub> = 37dBμ, R <sub>L</sub> = 45Ω	1.5	3.0		V
	Signal to Noise Ratio	S/N	V <sub>I</sub> = 37.5dBμ, R <sub>L</sub> = 8Ω P <sub>o</sub> = 50mW	15	20		dB
PWR AMP	Output Power	P <sub>o</sub>	f = 1KHz, THD = 10% V <sub>R</sub> Min, R <sub>L</sub> = 8Ω	0.28			W
	Total Harmonic Distortion	THD	I <sub>CC</sub> = 42mA, R <sub>L</sub> = 45Ω f = 1KHz, V <sub>o</sub> = 2V V <sub>R</sub> Min		0.5	4.0	%
	Voltage gain	G <sub>V</sub>	f = 1KHz, R <sub>L</sub> = 8Ω P <sub>o</sub> = 50mW		41		dB

TEST CIRCUIT

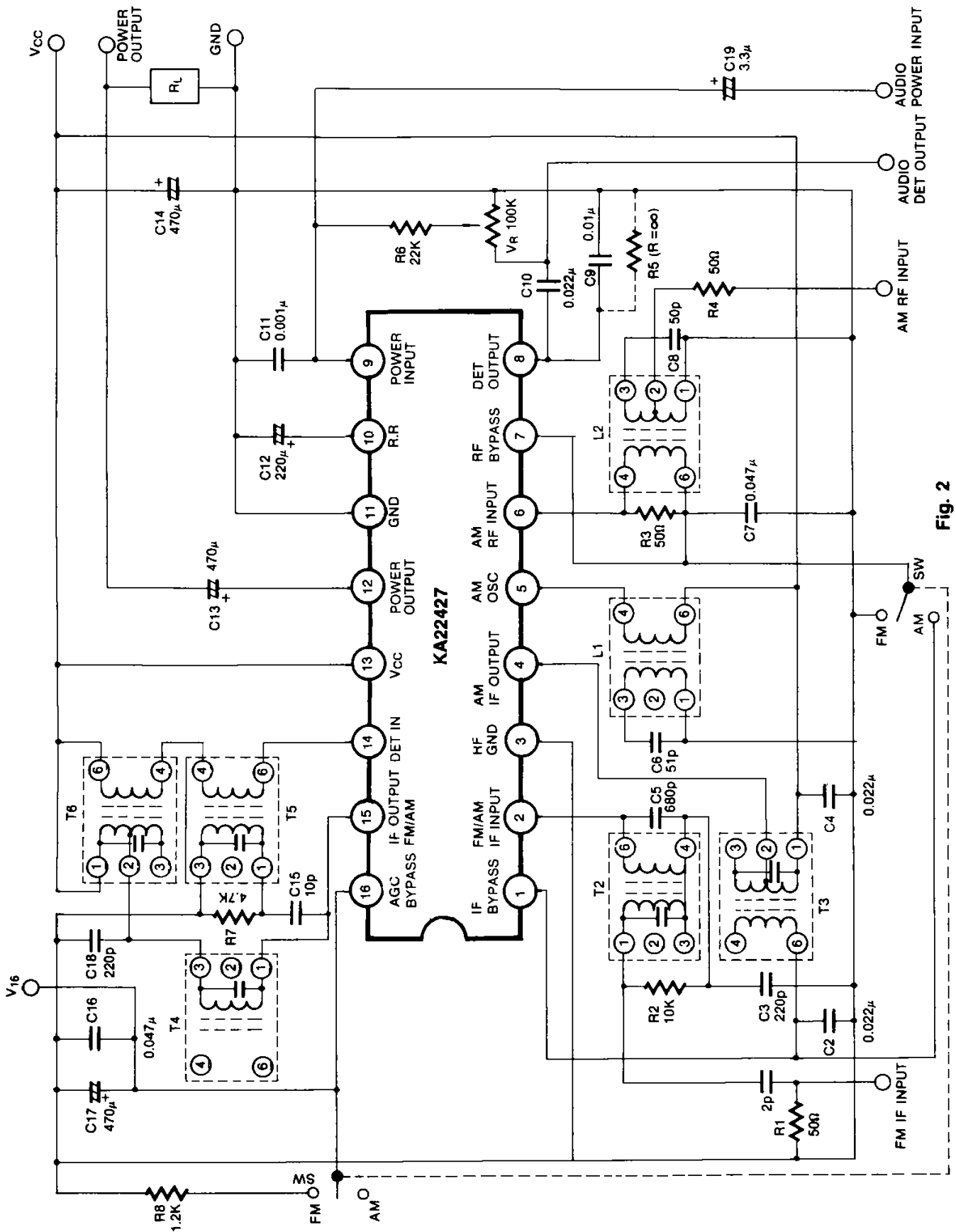

**APPLICATION INFORMATION****- EXTERNAL COMPONENTS**

Parts Number	Purpose	Typical	Influence	
			Smaller Than Typ	Greater Than Typ
R5	AM Gain Control	47K $\Omega$ (33K ~ $\infty$ )	Low AM Gain	AGC Distortion Increase, High Gain
R7	FM Detector Damper	4.7K $\Omega$	Low Detector Output, Stable IF Gain, Low FM Gain	Sharp IF AMP Curve
R8	FM Gain Adjust	470	Low FM Gain	High Gain, but Noise Increases
C2	IF Bypass	0.022 $\mu$ F	Should Not Be Less Than 0.005 $\mu$ F	High IF Gain, S/N Ratio Degrade
C4	IF Filter	0.022 $\mu$ F	Removal May Cause IF Oscillation	No Influence
C7	AM Bypass	0.047 $\mu$ F	Low Gain	Using over 1 $\mu$ F Will Cause FM Distortion at Small Signal
C9	Detector Filter	0.01 $\mu$ F	Unstable IF AMP Oscillation	Poor FM Frequency Response
C10	Audio Coupling	0.022 $\mu$ F	Lower Sensitivity, Poor Low Frequency Response	Bass Boost Affects De-emphasis Curve
C11	Audio Input High-Cut	0.001 $\mu$ F	Audio Oscillation	Poor Response
C12	Ripple Filter	220 $\mu$ F	Poor Frequency Response & Low Gain	Improves AC Hum
C13	Audio Output Coupling	470 $\mu$ F	Poor Low Frequency Response	Can Achieve Optimum Output Power
C14	Power Line Filter	470 $\mu$ F	Poor AC Hum	Improves AC Hum
C15	FM Detector Phase-Shift	10pF	Narrow IF Bandwidth	Wide IF Bandwidth
C16	High Freq. (IF) Bypass	0.047 $\mu$ F	Removal Will Cause FM Oscillation	No Influence
C17	AM AGC Time Constant and High Frequency (IF) Bypass	0.047 $\mu$ F	Not Recommend to Charge	

**FUNCTION DESCRIPTION (Pin 16 DC Voltage)****1. IF Gain Grouping Table****(1) Test Condition:**  $V_{CC} = 9V$  (Pin 13).Pin 8 resistance (AM) =  $47K\Omega$ .Pin 16 resistance (FM) =  $1.2K\Omega$ .**(2) Grouping Table**

V16 (AM)	1.4 – 1.7V	1.7 – 1.9V
V16 (FM)	C1	C2
2.6 – 3.0V		

**2. IF gain is determined by DC voltage appeared at IC Pin 16.**

The DC voltage at Pin 16 to the following values:

AM = 1.4 ~ 1.65V (DC)

FM = 1.9 ~ 2.10V (DC)

AM gain can be adjusted by the loading resistor value of Pin 8 (AM) from  $33K\Omega$  to infinity.FM gain can be adjusted by the loading resistor vale of Pin 16 (FM) from  $390\Omega$  to  $680\Omega$ .

Recommended resistance (Pin 8, Pin 16).

Pin 8 (AM) =  $47K\Omega$ Pin 16 (FM) =  $470\Omega$

# APPLICATION CIRCUIT 1

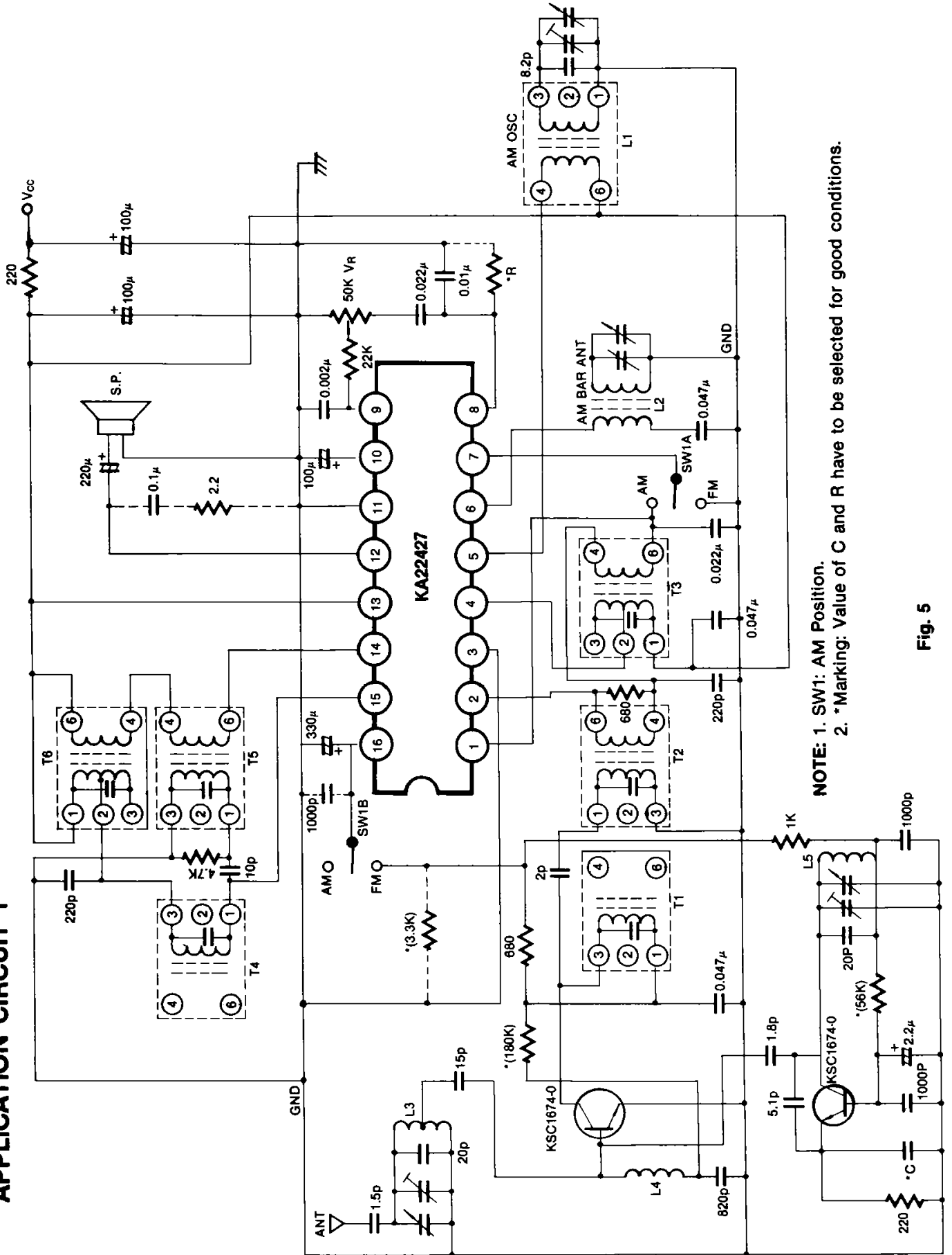

**NOTE:** 1. SW1: AM Position.  
 2. \*Marking: Value of C and R have to be selected for good conditions.

Fig. 5

## COIL SPECIFICATION 1

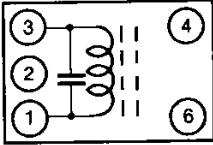
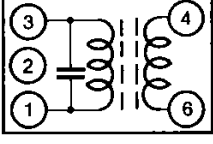
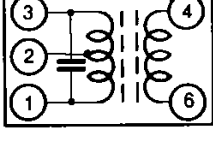
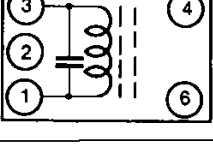
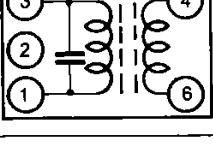
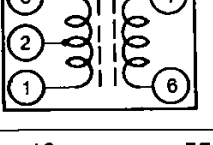
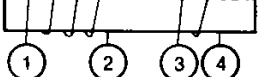
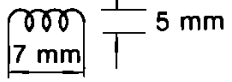
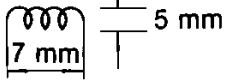
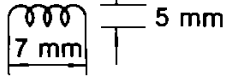
Coil No.	f	Q <sub>o</sub>	Turns		C <sub>o</sub>	Connections
T1	10.7MHz	120	1-3	8T	150pF	
T2	10.7MHz	70 min	1-3 4-6	11T 2T	75 ± 5pF	
T3 (T6)	455KHz	80 min	1-2 2-3 4-6	91T 55T 6T	180 ± 5pF	
T4	10.7MHz	45 min	1-3	11T	82 ± 3pF	
T5	10.7MHz	25 min	1-3 4-6	7T 7T	180pF	
L1	AM Local Oscillator	90 min	1-3 4-6	86T 7T		
L2	AM ANT	200	1-2 (L = 560μH) 3-4	138T 9T		Core: 10 mm ø × 55 mm  V.C GND Pin 6 GND
L3	FM ANT		0.8 mm ø UEW TAP	5T 0.5T		
L4	Trap		0.32 mm ø UEW	10T		
L5	FM Oscillator		0.8 mm ø UEW	4T	—	



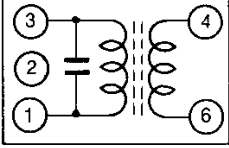
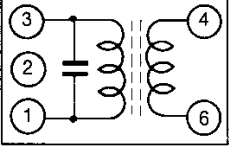
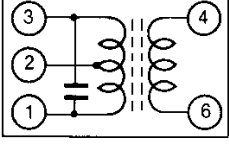
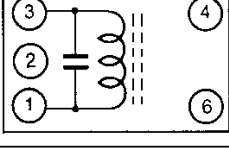
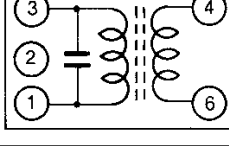
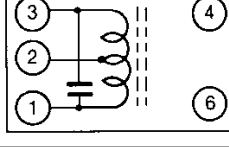
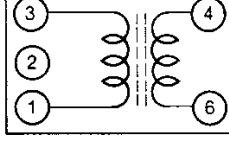

## COIL SPECIFICATION 2

Coil No.	f	Q <sub>0</sub>	Turns		C.L.	Connections
			1-3	4-6		
T1	10.7MHz	90	1-3	11	82pF	
			4-6	3		
T2	10.7MHz	60	1-3	5	390pF	
			4-6	2		
T3	455KHz	100	1-2	127	180pF	
			2-3	28		
			4-6	10		
T4	10.7MHz	45 (Min)	1-3	11	82pF	
T5	10.7MHz	25 (Min)	1-3	7	180pF	
			4-6	7		
T6	455KHz	100	1-2	50	390pF	
			2-3	50		
L6	796KHz	100	1-3	100	360μH	
			4-6	10		