



## 64K × 16 HIGH-SPEED CMOS STATIC RAM

### GENERAL DESCRIPTION

The W26L010A is a high-speed, low-power CMOS static RAM organized as 65,536 × 16 bits that operates on a single 3.3-volt power supply. This device is manufactured using Winbond's high performance CMOS technology.

The W26L010A has an active low chip select, separate upper and lower byte selects, and a fast output enable. No clock or refreshing is required. Separate byte select controls ( $\overline{\text{LB}}$  and  $\overline{\text{UB}}$ ) allow individual bytes to be written and read.  $\overline{\text{LB}}$  controls I/O1-I/O8, the lower byte.  $\overline{\text{UB}}$  controls I/O9-I/O16, the upper byte. This device is well suited for use in high-density, high-speed system applications.

### FEATURES

- High speed access time: 10/12 nS (max.)
- Low power consumption:
  - Active: 530 mW (max.)
- Single +3.3V power supply
- Fully static operation
  - No clock or refreshing
- All inputs and outputs directly TTL compatible
- Three-state outputs
- Data byte control
  - $\overline{\text{LB}}$  (I/O1-I/O8),  $\overline{\text{UB}}$  (I/O9-I/O16)
- Available packages: 44-pin 400 mil SOJ and 44-pin TSOP(II)

### PIN CONFIGURATION

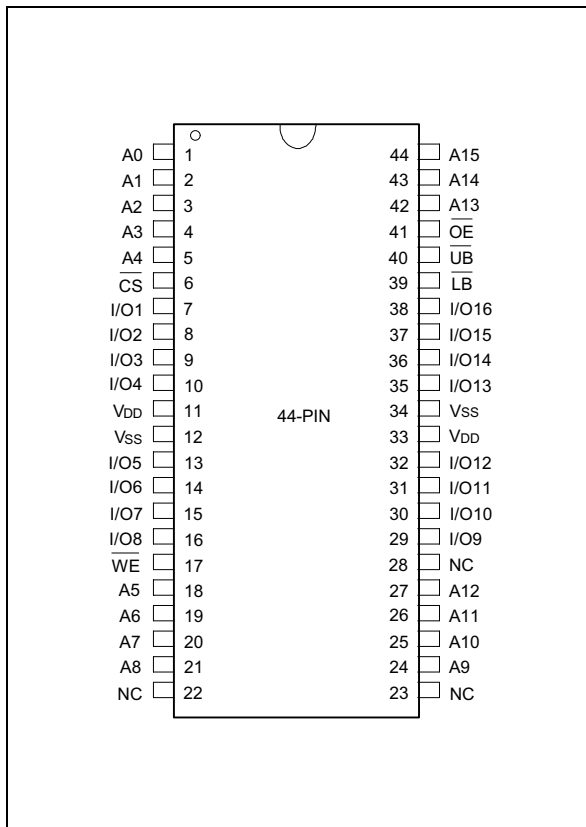

### BLOCK DIAGRAM

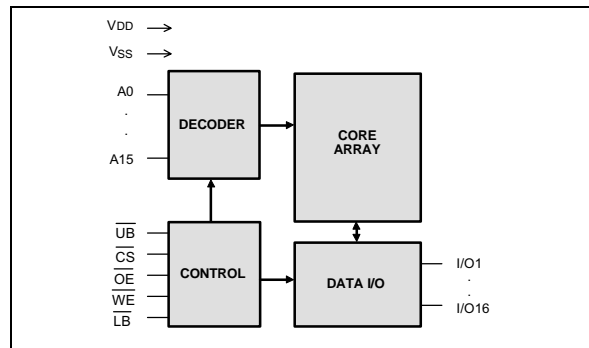

### PIN DESCRIPTION

SYMBOL	DESCRIPTION
A0-A15	Address Inputs
I/O1-I/O16	Data Inputs/Outputs
$\overline{\text{CS}}$	Chip Select Inputs
$\overline{\text{WE}}$	Write Enable Input
$\overline{\text{OE}}$	Output Enable Input
$\overline{\text{LB}}$	Lower Byte Select I/O1-I/O8
$\overline{\text{UB}}$	Upper Byte Select I/O9-I/O16
VDD	Power Supply
VSS	Ground
NC	No Connection



## TRUTH TABLE

$\overline{\text{CS}}$	$\overline{\text{OE}}$	$\overline{\text{WE}}$	$\overline{\text{LB}}$	$\overline{\text{UB}}$	MODE	I/O1–I/O8	I/O9–I/O16	V <sub>DD</sub> CURRENT
H	X	X	X	X	Not Selected	High Z	High Z	I <sub>SB</sub> , I <sub>SB1</sub>
L	H	H	X	X	Output Disable	High Z	High Z	I <sub>DD</sub>
L	L	H	L	L	2 Bytes Read	DOUT	DOUT	I <sub>DD</sub>
L	L	H	L	H	Lower Byte Read	DOUT	High Z	I <sub>DD</sub>
L	L	H	H	L	Upper Byte Read	High Z	DOUT	I <sub>DD</sub>
L	X	L	L	L	2 Bytes Write	DIN	DIN	I <sub>DD</sub>
L	X	L	L	H	Lower Byte Write	DIN	High Z	I <sub>DD</sub>
L	X	L	H	L	Upper Byte Write	High Z	DIN	I <sub>DD</sub>
L	X	X	H	H	Output Disable	High Z	High Z	I <sub>DD</sub>

## DC CHARACTERISTICS

### Absolute Maximum Ratings

PARAMETER	RATING	UNIT
Supply Voltage to V <sub>SS</sub> Potential	-0.5 to +4.6	V
Input/Output to V <sub>SS</sub> Potential	-0.5 to V <sub>DD</sub> +0.5	V
Allowable Power Dissipation	1.5	W
Storage Temperature	-65 to +150	°C
Operating Temperature	0 to +70	°C

Note: Exposure to conditions beyond those listed under Absolute Maximum Ratings may adversely affect the life and reliability of the device.



## Operating Characteristics

(V<sub>DD</sub> = 3.3V ±5%, V<sub>SS</sub> = 0V, T<sub>A</sub> = 0 to 70° C)

PARAMETER	SYM.	TEST CONDITIONS	MIN.	TYP.	MAX.	UNIT	
Input Low Voltage	V <sub>IL</sub>	-	-0.5	-	+0.8	V	
Input High Voltage	V <sub>IH</sub>	-	+2.0	-	V <sub>DD</sub> +0.3	V	
Input Leakage Current	I <sub>LI</sub>	V <sub>IN</sub> = V <sub>SS</sub> to V <sub>DD</sub>	-10	-	+10	μA	
Output Leakage Current	I <sub>LO</sub>	V <sub>I/O</sub> = V <sub>SS</sub> to V <sub>DD</sub> Output Pins in High Z, See Truth Table	-10	-	+10	μA	
Output Low Voltage	V <sub>OL</sub>	I <sub>OL</sub> = +8.0 mA	-	-	0.4	V	
Output High Voltage	V <sub>OH</sub>	I <sub>OH</sub> = -4.0 mA	2.4	-	-	V	
Operating Power	I <sub>DD</sub>	$\overline{CS}$ = V <sub>IL</sub> (max.), Cycle = min.	10	-	-	160	mA
Supply Current		I/O = open, Duty = 100%	12	-	-	140	
Standby Power	I <sub>SB</sub>	$\overline{CS}$ = V <sub>IH</sub> (min.), Cycle = min.	-	-	30	mA	
Supply Current	I <sub>SB1</sub>	$\overline{CS}$ = V <sub>DD</sub> -0.2V, I/O = open All other pins = V <sub>DD</sub> -0.2V/GND	-	-	10	mA	

Note: Typical characteristics are evaluated at V<sub>DD</sub> = 3.3V, T<sub>A</sub> = 25° C.

## CAPACITANCE

(V<sub>DD</sub> = 3.3V, T<sub>A</sub> = 25° C, f = 1 MHz)

PARAMETER	SYM.	CONDITIONS	MAX.	UNIT
Input Capacitance	C <sub>IN</sub>	V <sub>IN</sub> = 0V	6	pF
Input/Output Capacitance	C <sub>I/O</sub>	V <sub>OUT</sub> = 0V	8	pF

Note: These parameters are sampled but not 100% tested.

## AC CHARACTERISTICS

### AC Test Conditions

PARAMETER	CONDITIONS
Input Pulse Levels	0V to 3V
Input Rise and Fall Times	2 nS
Input and Output Timing Reference Level	1.5V
Output Load	C <sub>L</sub> = 30 pF, I <sub>OH</sub> /I <sub>OL</sub> = -4 mA/8 mA

## AC Test Loads and Waveform

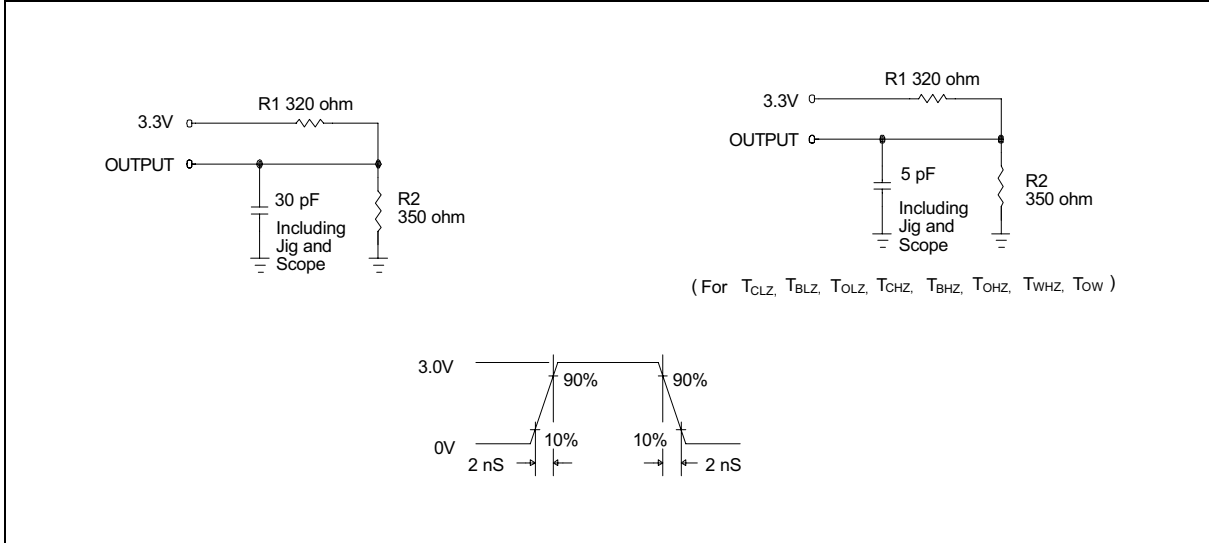

( $V_{DD} = 3.3V \pm 5\%$ ,  $V_{SS} = 0V$ ,  $T_A = 0$  to  $70^\circ C$ )

### (1) Read Cycle

PARAMETER	SYM.	W26L010A-10		W26L010A-12		UNIT
		MIN.	MAX.	MIN.	MAX.	
Read Cycle Time	TRC	10	-	12	-	nS
Address Access Time	TAA	-	10	-	12	nS
Chip Select Access Time	TACS	-	10	-	12	nS
Output Enable to Output Valid	TOE	-	5	-	6	nS
$\overline{UB}$ , $\overline{LB}$ Access Time	TBA	-	5	-	6	nS
Output Hold from Address Change	TOH	3	-	3	-	nS
Chip Select to Output in Low Z	TCLZ*	3	-	3	-	nS
Chip Deselect to Output in High Z	TCHZ*	-	5	-	6	nS
Output Enable to Output in Low Z	TOLZ*	0	-	0	-	nS
Output Disable to Output in High Z	TOHZ*	-	5	-	6	nS
$\overline{UB}$ , $\overline{LB}$ Select to Output in Low Z	TBLZ*	0	-	0	-	nS
$\overline{UB}$ , $\overline{LB}$ Deselect to Output in High Z	TBHZ*	-	5	-	6	nS

\* These parameters are sampled but not 100% tested.



AC Characteristics, continued

## (2) Write Cycle

PARAMETER	SYM.	W26L010A-10		W26L010A-12		UNIT
		MIN.	MAX.	MIN.	MAX.	
Write Cycle Time	TWC	10	–	12	–	nS
Chip Select to End of Write	TCW	9	–	10	–	nS
Address Valid to End of Write	TAW	9	–	10	–	nS
Address Setup Time	TAS	0	–	0	–	nS
$\overline{UB}$ , $\overline{LB}$ Select to End of Write	TBW	9	–	10	–	nS
Write Pulse Width	TWP	9	–	10	–	nS
Write Recovery Time	$\overline{CS}$ , $\overline{WE}$ TWR	0	–	0	–	nS
Data Valid to End of Write	TDW	6	–	7	–	nS
Data Hold from End of Write	TDH	0	–	0	–	nS
Write to Output in High Z	TWHZ*	–	6	–	7	nS
End of Write to Output Active	TOW*	3	–	3	–	nS

\* These parameters are sampled but not 100% tested.



### Timing Waveforms

#### Read Cycle 1

(Address Controlled,  $\overline{CS} = \overline{OE} = \overline{UB} = \overline{LB} = V_{IL}, \overline{WE} = V_{IH}$ )

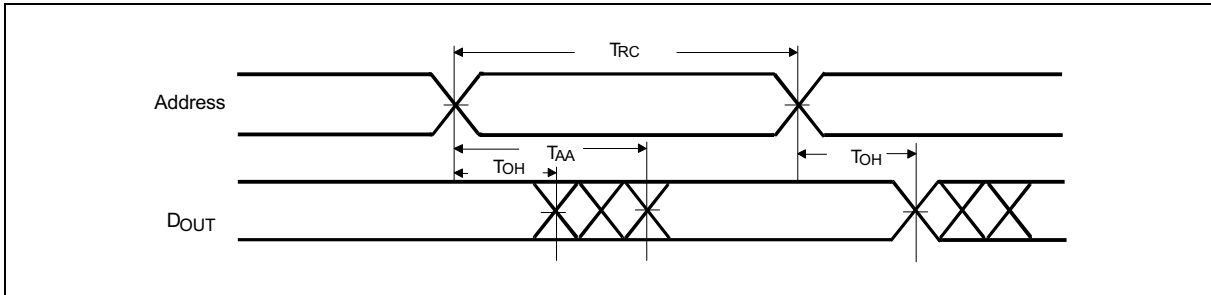

#### Read Cycle 2

(Chip Select Controlled,  $\overline{OE} = V_{IL}, \overline{WE} = V_{IH}$ )

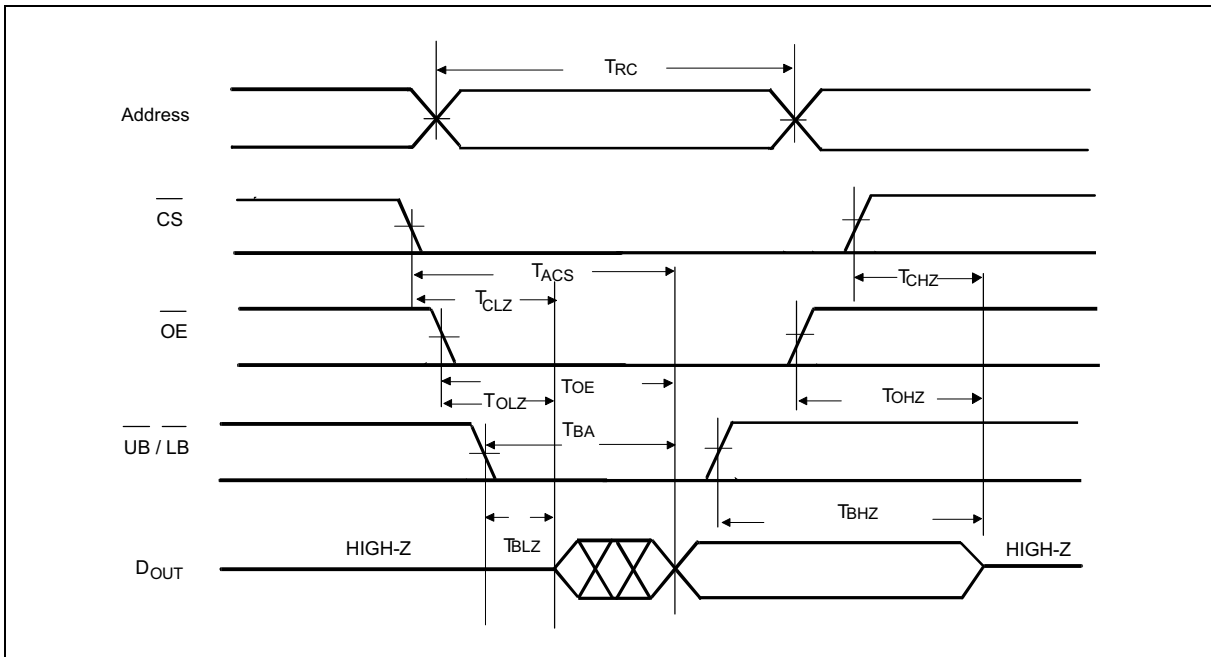

Notes:

1.  $\overline{WE}$  is high for read cycle.
2. Device is continuously selected.  
 $\overline{CS} = \overline{OE} = \overline{LB} = \text{Low}$   
 $\overline{CS} = \overline{OE} = \overline{LB} = \text{Low}$
3. Address valid prior to or coincident with  $\overline{CS}$  transition low.



Timing Waveforms, continued

**Read Cycle 3**

(Output Enable Controlled,  $\overline{CS} = \overline{UB} = \overline{LB} = V_{IL}, \overline{WE} = V_{IH}$ )

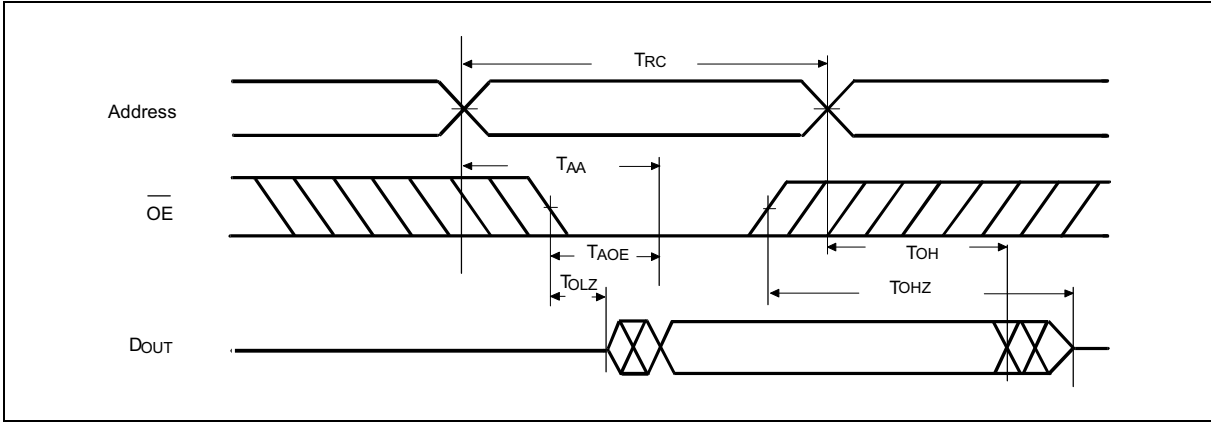

**Write Cycle 1**

(OE Clock)

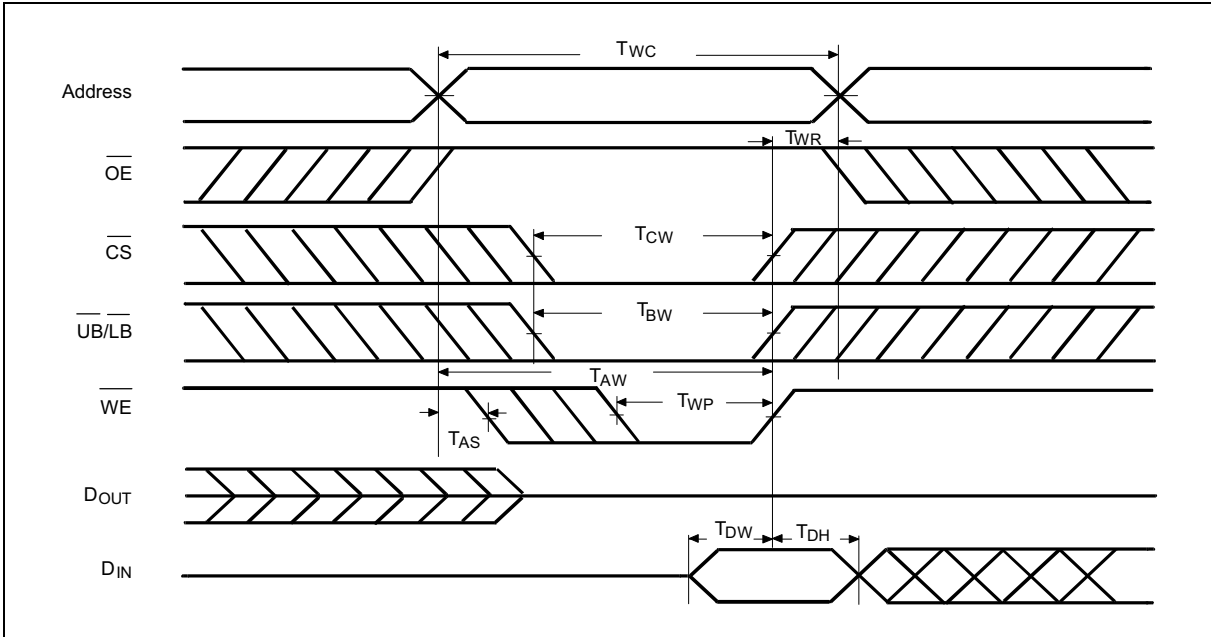



Timing Waveforms, continued

## Write Cycle 2

( $\overline{OE} = V_{IL}$  Fixed)

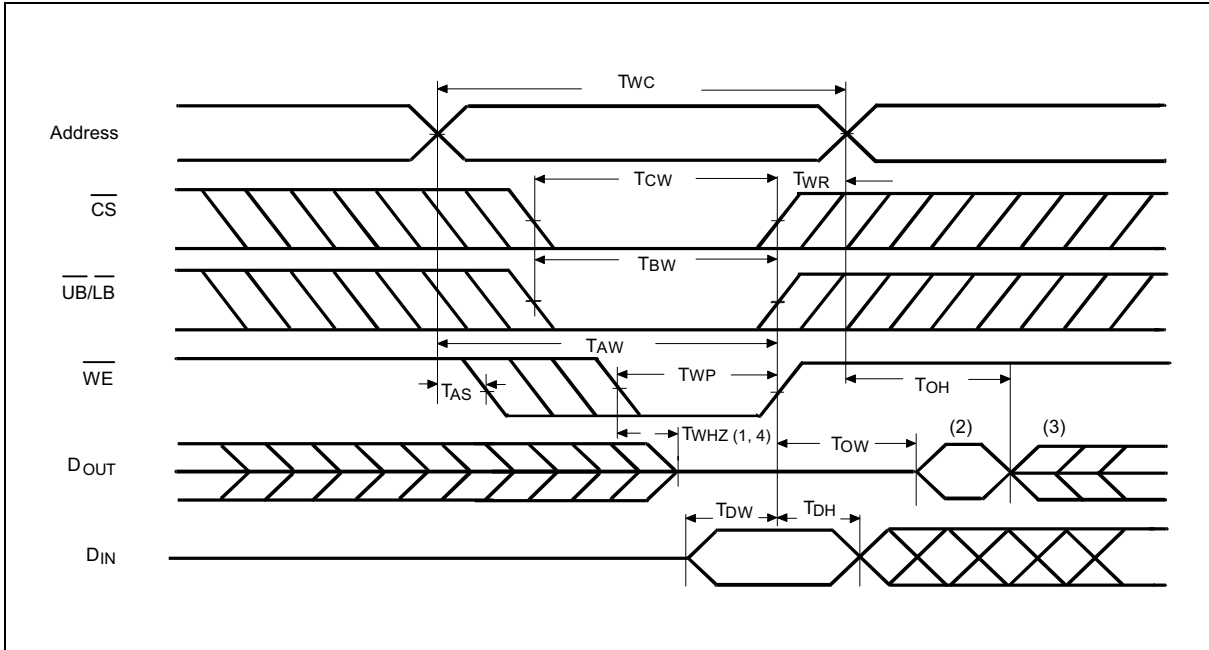

Notes:

1. During this period, I/O pins are in the output state, so input signals of opposite phase to the outputs should not be applied.
2. The data output from DOUT are the same as the data written to DIN during the write cycle.
3. DOUT provides the read data for the next address.
4. Transition is measured  $\pm 500$  mV from steady state with  $C_L = 5$  pF. This parameter is guaranteed but not 100% tested.

## ORDERING INFORMATION

PART NO.	ACCESS TIME (nS)	OPERATING CURRENT MAX. (mA)	STANDBY CURRENT MAX. (mA)	PACKAGE
W26L010AJ-10	10	160	10	44-pin 400 mil SOJ
W26L010AJ-12	12	140	10	44-pin 400 mil SOJ
W26L010AT-10	10	160	10	44-pin TSOP
W26L010AT-12	12	140	10	44-pin TSOP

Notes:

1. Winbond reserves the right to make changes to its products without prior notice.
2. Purchasers are responsible for performing appropriate quality assurance testing on products intended for use in applications where personal injury might occur as a consequence of product failure.



## PACKAGE DIMENSIONS

### 44-pin Small Outline J Band

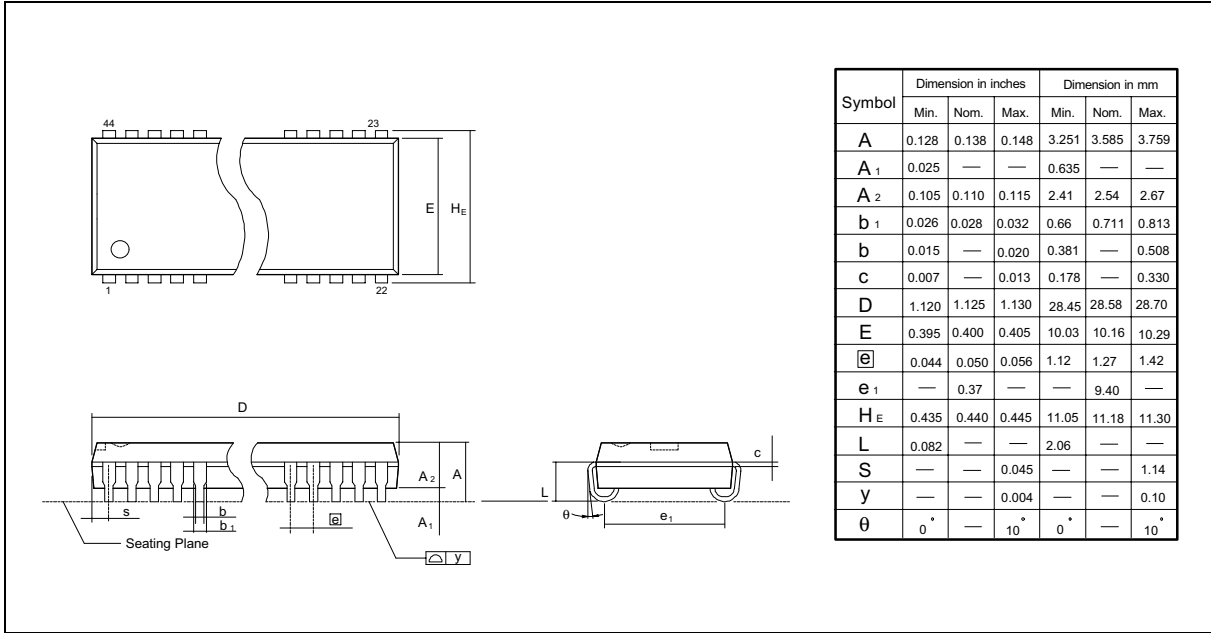

### 44-pin Standard Type Two TSOP

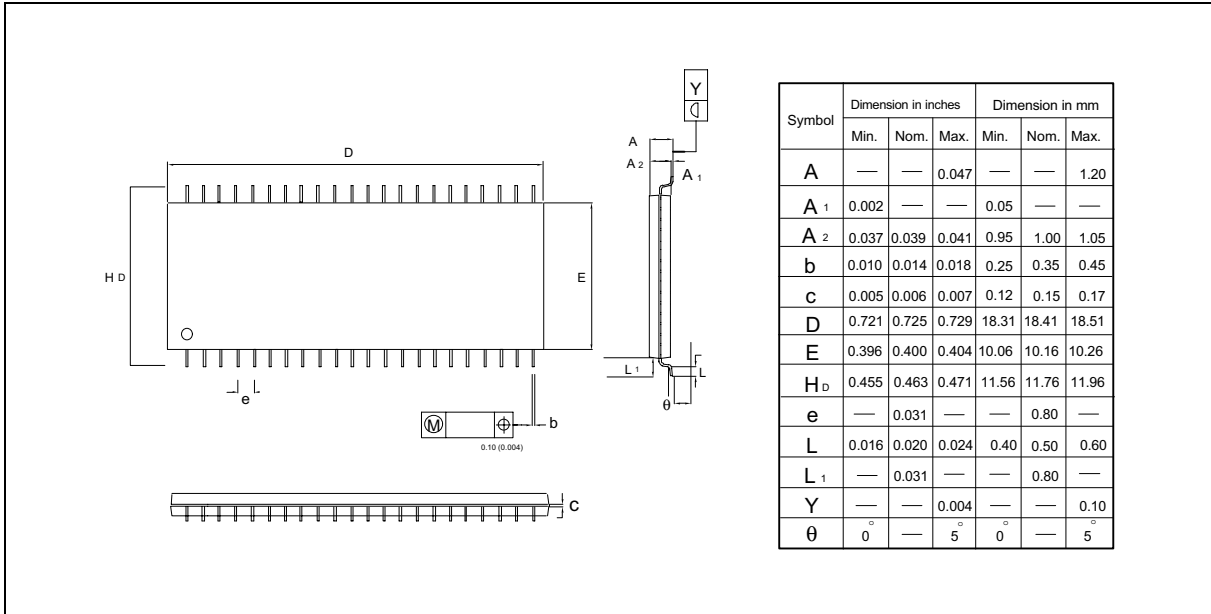



## VERSION HISTORY

VERSION	DATE	PAGE	DESCRIPTION
A1	May 1995		Initial Issued
A2	Feb. 1998	1, 3, 4, 5, 8	Change the relative specification from 15/20 nS to 10/12 nS
		1, 8, 9	Add TSOP package
		6, 7	Modify timing waveforms
A3	Jul. 1998	3, 4	Revise Vcc from 3.3V $\pm$ 10% to 3.3V $\pm$ 5%



### Headquarters

No. 4, Creation Rd. III,  
Science-Based Industrial Park,  
Hsinchu, Taiwan  
TEL: 886-3-5770066  
FAX: 886-3-5796096  
<http://www.winbond.com.tw/>  
Voice & Fax-on-demand: 886-2-27197006

### Taipei Office

11F, No. 115, Sec. 3, Min-Sheng East Rd.,  
Taipei, Taiwan  
TEL: 886-2-27190505  
FAX: 886-2-27197502

### Winbond Electronics (H.K.) Ltd.

Rm. 803, World Trade Square, Tower II,  
123 Hoi Bun Rd., Kwun Tong,  
Kowloon, Hong Kong  
TEL: 852-27513100  
FAX: 852-27552064

### Winbond Electronics North America Corp.

**Winbond Memory Lab.**  
**Winbond Microelectronics Corp.**  
**Winbond Systems Lab.**  
2727 N. First Street, San Jose,  
CA 95134, U.S.A.  
TEL: 408-9436666  
FAX: 408-5441798

Note: All data and specifications are subject to change without notice.