

SWITCHMODE™

Soft Recovery Power Rectifier

Plastic TO-220 Package

MSR860

**SOFT RECOVERY
POWER RECTIFIER
8.0 AMPERES
600 VOLTS**

Designed for use as free wheeling diodes in variable speed motor control applications and other average frequency switching power supplies. These state-of-the-art devices have the following features:

- Soft Recovery with Guaranteed Low Reverse Recovery Charge (Q_{RR}) and Peak Reverse Recovery Current (I_{RRM})
- 150°C Operating Junction Temperature
- Popular TO-220 Package
- Epoxy meets UL94, $V_0 @ 1/8''$
- Low Forward Voltage
- Low Leakage Current
- High Temperature Glass Passivated Junction

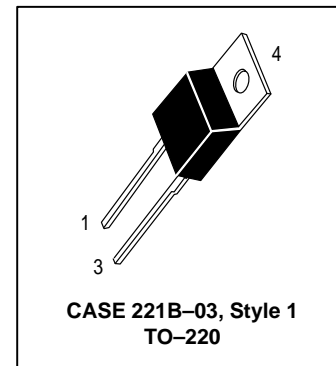
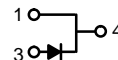

Mechanical Characteristics:

- Case: Molded Epoxy
- Weight: 1.9 Grams (approximately)
- Finish: All External Surfaces Corrosion Resistant and Terminal Leads Readily Solderable
- Lead Temperature for Soldering Purposes: 260°C Max. for 10 Seconds
- Shipped in 50 Units per Plastic Tube
- Marking: MSR860

MAXIMUM RATINGS

Rating	Symbol	Value	Unit
Peak Repetitive Reverse Voltage Working Peak Reverse Voltage DC Blocking Voltage	V_{RRM} V_{RWM} V_R	600	V
Average Rectified Forward Current (At Rated V_R , $T_C = 125^\circ\text{C}$)	I_O	8.0	A
Peak Repetitive Forward Current (At Rated V_R , Square Wave, 20 kHz, $T_C = 125^\circ\text{C}$)	I_{FRM}	16	A
Non-Repetitive Peak Surge Current (Surge applied at rated load conditions, halfwave, single phase, 60 Hz)	I_{FSM}	100	A
Storage / Operating Case Temperature	T_{stg}, T_C	- 65 to 150	$^\circ\text{C}$
Operating Junction Temperature	T_J	- 65 to 150	$^\circ\text{C}$

THERMAL CHARACTERISTICS

Thermal Resistance — Junction-to-Case	$R_{\theta JC}$	1.6	$^\circ\text{C/W}$
Thermal Resistance — Junction-to-Ambient	$R_{\theta JA}$	72.8	$^\circ\text{C/W}$

ELECTRICAL CHARACTERISTICS

Maximum Instantaneous Forward Voltage (1) ($I_F = 8.0 \text{ A}$) <i>Typical</i>	V_F	$T_J = 25^\circ\text{C}$	$T_J = 150^\circ\text{C}$	V
		1.7 1.4	1.3 1.1	
Maximum Instantaneous Reverse Current ($V_R = 600 \text{ V}$) <i>Typical</i>	I_R	$T_J = 25^\circ\text{C}$	$T_J = 150^\circ\text{C}$	μA
		10 2.0	1000 80	
Maximum Reverse Recovery Time (2) ($V_R = 400 \text{ V}$, $I_F = 8.0 \text{ A}$, $di/dt = 200 \text{ A}/\mu\text{s}$) <i>Typical</i>	t_{rr}	$T_J = 25^\circ\text{C}$	$T_J = 125^\circ\text{C}$	ns
		120 95	190 125	
Typical Recovery Softness Factor ($V_R = 400 \text{ V}$, $I_F = 8.0 \text{ A}$, $di/dt = 200 \text{ A}/\mu\text{s}$)	$s = t_b/t_a$	2.5	3.0	
Maximum Peak Reverse Recovery Current ($V_R = 400 \text{ V}$, $I_F = 8.0 \text{ A}$, $di/dt = 200 \text{ A}/\mu\text{s}$)	I_{RRM}	5.8	8.3	A
Maximum Reverse Recovery Charge ($V_R = 400 \text{ V}$, $I_F = 8.0 \text{ A}$, $di/dt = 200 \text{ A}/\mu\text{s}$)	Q_{RR}	350	700	nC

(1) Pulse Test: Pulse Width $\leq 380 \mu\text{s}$, Duty Cycle $\leq 2\%$

(2) T_{RR} measured projecting from 25% of I_{RRM} to zero current

Switchmode is a trademark of Motorola, Inc.

TYPICAL ELECTRICAL CHARACTERISTICS

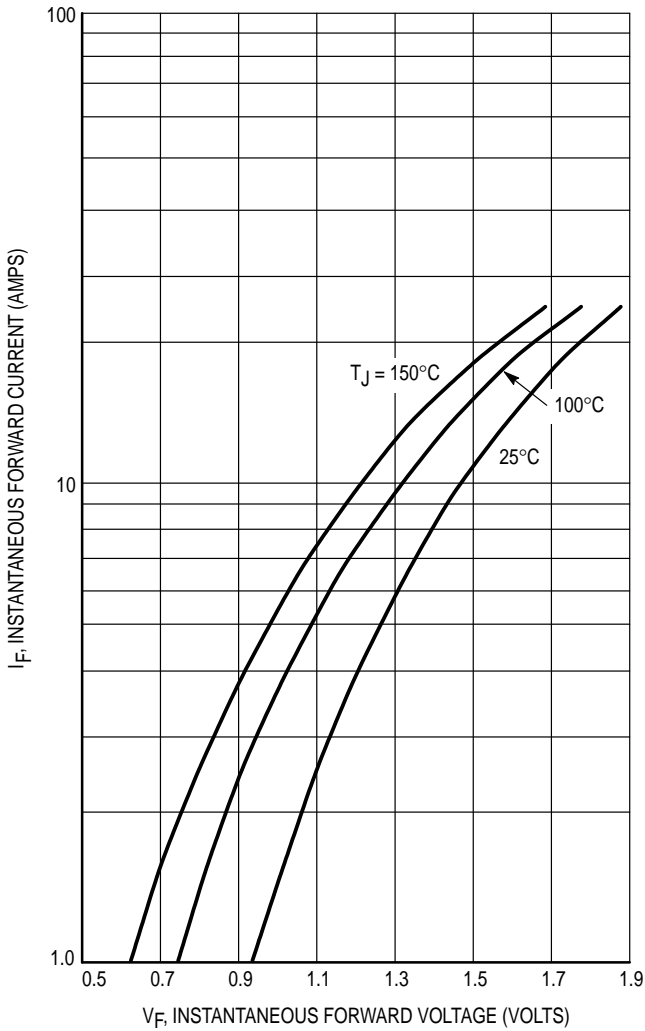

Figure 1. Typical Forward Voltage

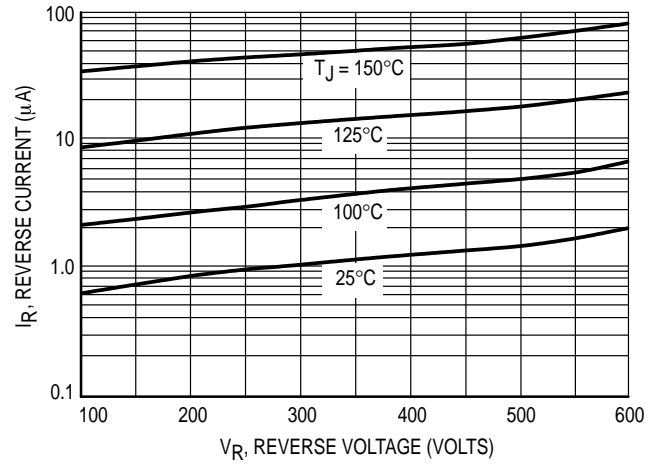

Figure 2. Typical Reverse Current

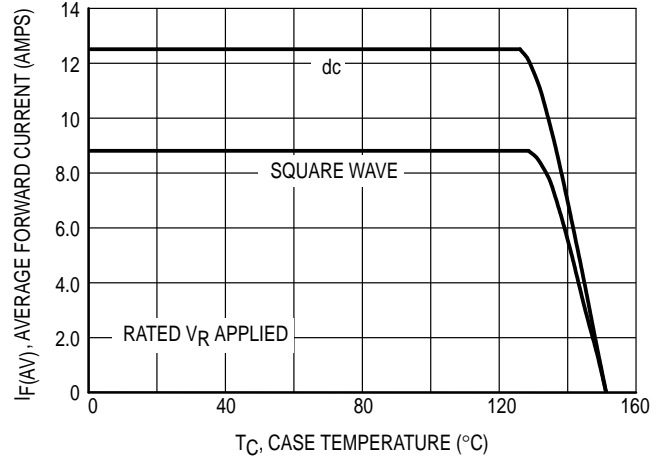

Figure 3. Current Derating, Case

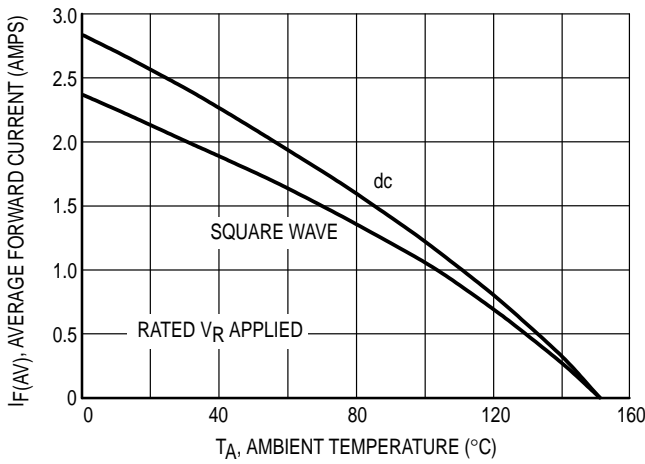

Figure 4. Current Derating, Ambient

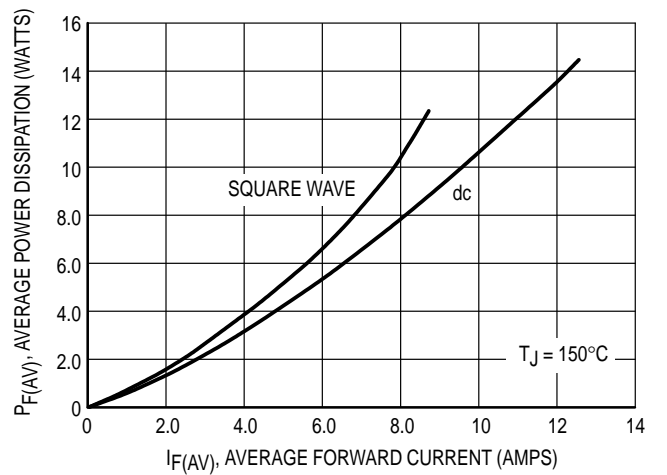

Figure 5. Power Dissipation

TYPICAL ELECTRICAL CHARACTERISTICS

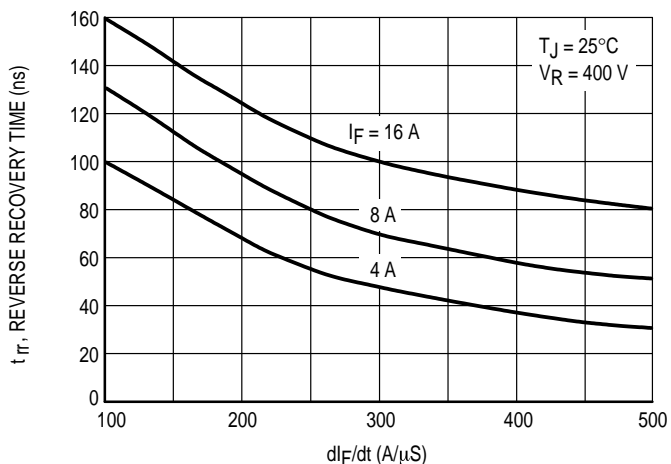

Figure 6. Typical Reverse Recovery Time

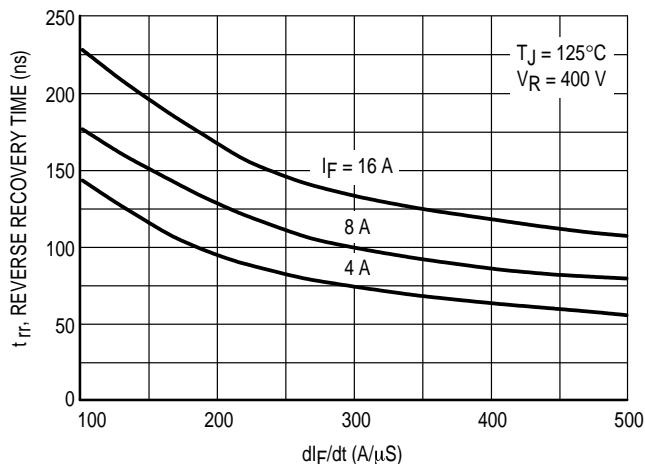

Figure 7. Typical Reverse Recovery Time

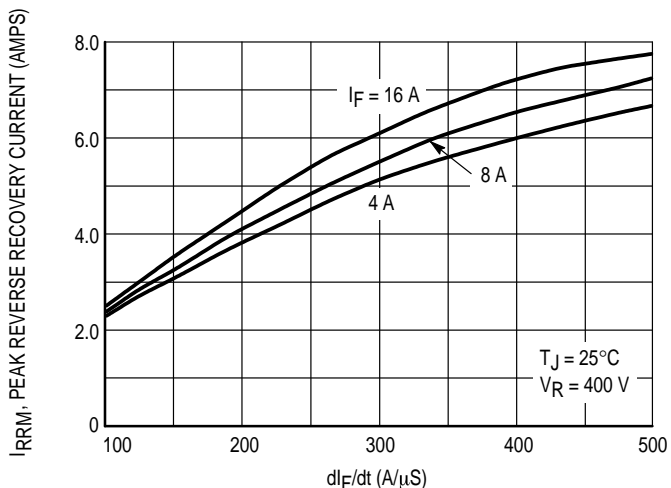

Figure 8. Typical Peak Reverse Recovery Current

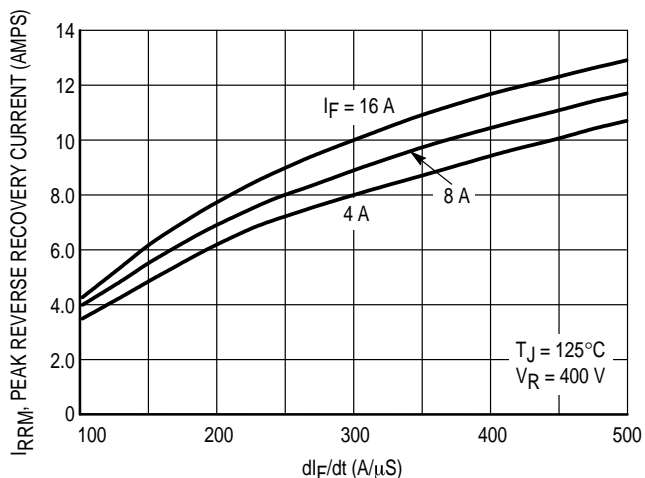

Figure 9. Typical Peak Reverse Recovery Current

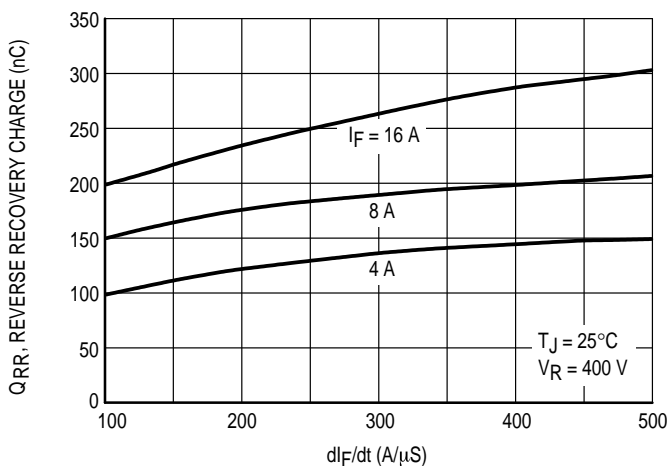

Figure 10. Typical Reverse Recovery Charge

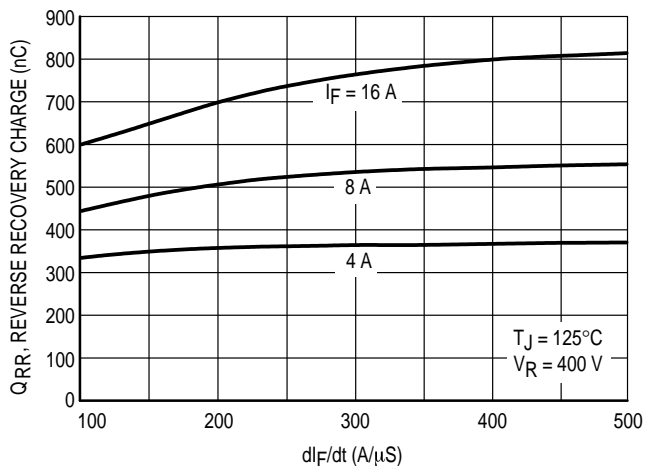

Figure 11. Typical Reverse Recovery Charge

MSR860

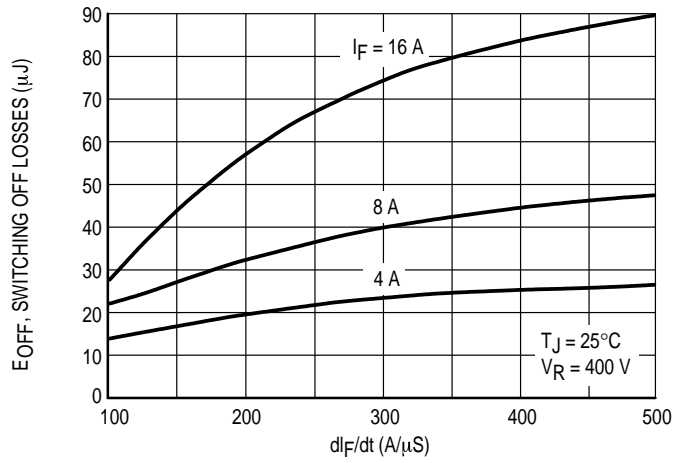

Figure 12. Typical Switching Off Losses

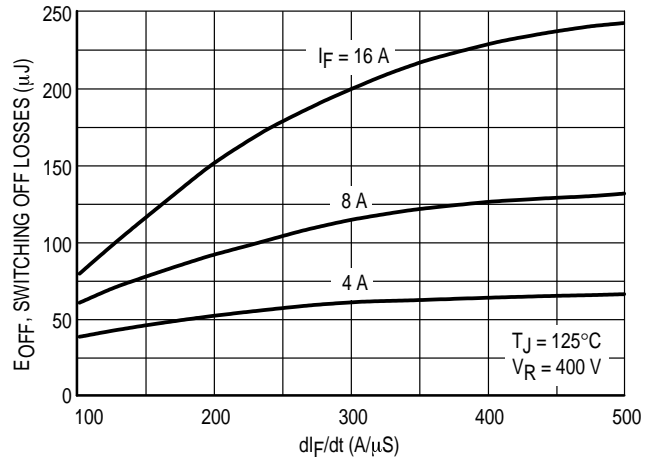

Figure 13. Typical Switching Off Losses

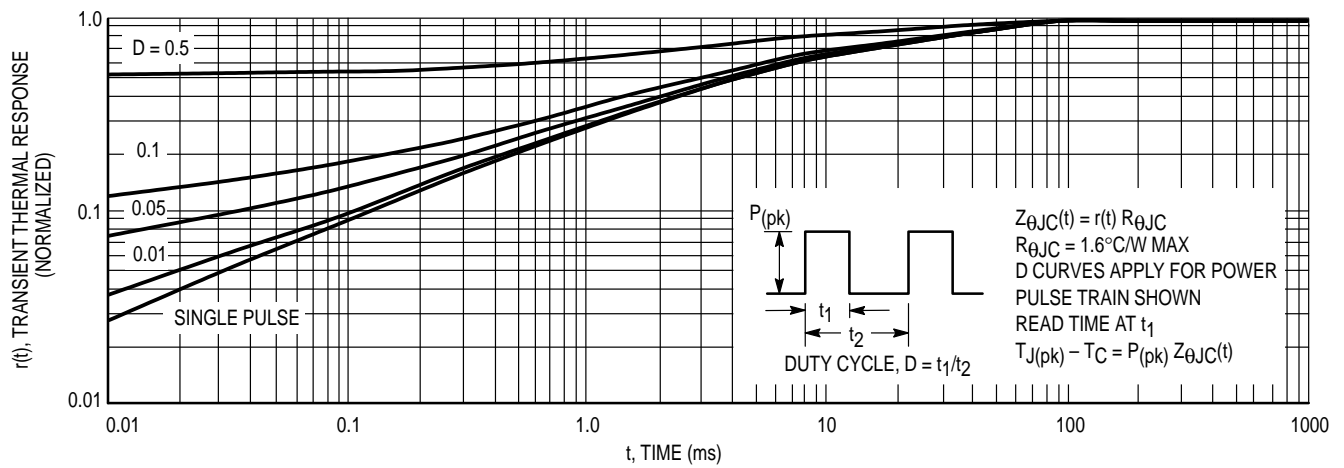
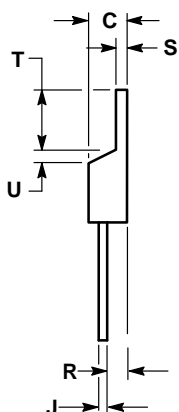
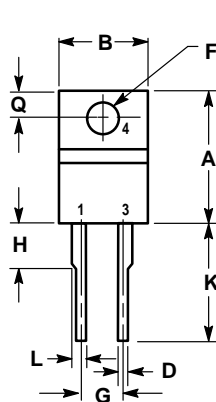

Figure 14. Thermal Response

PACKAGE DIMENSIONS



NOTES:

1. DIMENSIONING AND TOLERANCING PER ANSI Y14.5M, 1982.
2. CONTROLLING DIMENSION: INCH.

DIM	INCHES		MILLIMETERS	
	MIN	MAX	MIN	MAX
A	0.595	0.620	15.11	15.75
B	0.380	0.405	9.65	10.29
C	0.160	0.190	4.06	4.82
D	0.025	0.035	0.64	0.89
F	0.142	0.147	3.61	3.73
G	0.190	0.210	4.83	5.33
H	0.110	0.130	2.79	3.30
J	0.018	0.025	0.46	0.64
K	0.500	0.562	12.70	14.27
L	0.045	0.060	1.14	1.52
Q	0.100	0.120	2.54	3.04
R	0.080	0.110	2.04	2.79
S	0.045	0.055	1.14	1.39
T	0.235	0.255	5.97	6.48
U	0.000	0.050	0.00	1.27

STYLE 1:

1. CATHODE
2. N/A
3. ANODE
4. CATHODE

**CASE 221B-03
ISSUE B**

Motorola reserves the right to make changes without further notice to any products herein. Motorola makes no warranty, representation or guarantee regarding the suitability of its products for any particular purpose, nor does Motorola assume any liability arising out of the application or use of any product or circuit, and specifically disclaims any and all liability, including without limitation consequential or incidental damages. "Typical" parameters which may be provided in Motorola data sheets and/or specifications can and do vary in different applications and actual performance may vary over time. All operating parameters, including "Typicals" must be validated for each customer application by customer's technical experts. Motorola does not convey any license under its patent rights nor the rights of others. Motorola products are not designed, intended, or authorized for use as components in systems intended for surgical implant into the body, or other applications intended to support or sustain life, or for any other application in which the failure of the Motorola product could create a situation where personal injury or death may occur. Should Buyer purchase or use Motorola products for any such unintended or unauthorized application, Buyer shall indemnify and hold Motorola and its officers, employees, subsidiaries, affiliates, and distributors harmless against all claims, costs, damages, and expenses, and reasonable attorney fees arising out of, directly or indirectly, any claim of personal injury or death associated with such unintended or unauthorized use, even if such claim alleges that Motorola was negligent regarding the design or manufacture of the part. Motorola and  are registered trademarks of Motorola, Inc. Motorola, Inc. is an Equal Opportunity/Affirmative Action Employer.

Mfax is a trademark of Motorola, Inc.

How to reach us:

USA/EUROPE/Locations Not Listed: Motorola Literature Distribution;
P.O. Box 5405, Denver, Colorado 80217. 303-675-2140 or 1-800-441-2447

JAPAN: Nippon Motorola Ltd.; Tatsumi-SPD-JLDC, 6F Seibu-Butsuryu-Center,
3-14-2 Tatsumi Koto-Ku, Tokyo 135, Japan. 81-3-3521-8315

Mfax™: RMFAX0@email.sps.mot.com – TOUCHTONE 602-244-6609
INTERNET: <http://Design-NET.com>

ASIA/PACIFIC: Motorola Semiconductors H.K. Ltd.; 8B Tai Ping Industrial Park,
51 Ting Kok Road, Tai Po, N.T., Hong Kong. 852-26629298

**MOTOROLA**