



2-INPUT 3CHANNEL VIDEO SWITCH

■ GENERAL DESCRIPTION

NJM2286 is a switching IC for switching over from one audio or video input signal to another. Internalizing 2 inputs, 1 output, and then each set of 3 can be operated independently. They are a "Clamp type" and it can be operated while DC level fixed in position of the video signal. It is a higher efficiency video switch, featuring the operating supply voltage 4.75 to 13.0V, the frequency feature 10MHz, and then the Crosstalk 75dB (at 4.43MHz).

■ PACKAGE OUTLINE

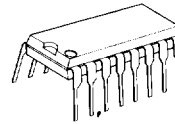

NJM2286D

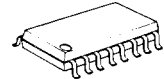

NJM2286M

■ FEATURES

- 2 Input-1 Output Internalizing 3 Circuits (Clamp type).
- Wide Operating Voltage (4.75 ~ 13.0V)
- Crosstalk 75dB(at 4.43MHz)
- Wide Bandwidth Frequency Feature 10MHz(2V_{p-p} Input)
- Package Outline DIP16, DMP16
- Bipolar Technology

■ APPLICATIONS

- VCR, Video Camera, AV-TV, Video Disk Player.

■ BLOCK DIAGRAM

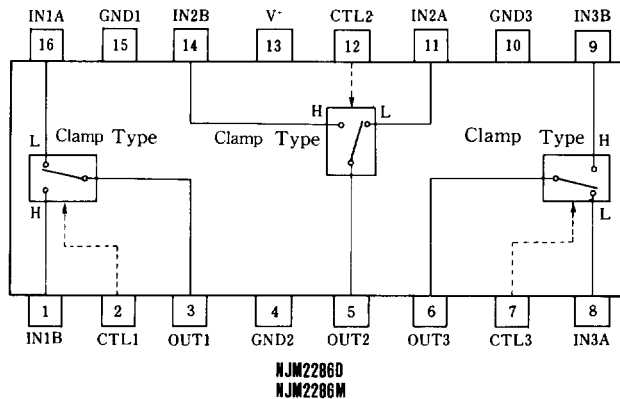



■ MAXIMUM RATINGS

(Ta=25°C)

PARAMETER	SYMBOL	RATINGS	UNIT
Supply Voltage	V ⁺	14	V
Power Dissipation	P _D	(DIP16) 700	mW
		(DMP16) 350	mW
Operating Temperature Range	T _{opr}	-20 ~ +75	°C
Storage Temperature Range	T _{stg}	-40 ~ +125	°C

■ ELECTRICAL CHARACTERISTICS

(V⁺=5V, Ta=25°C)

PARAMETER	SYMBOL	TEST CONDITION	MIN.	TYP.	MAX.	UNIT
Operating Current (1)	I _{CC1}	V ⁺ =5V (Note1)	7.9	11.3	14.7	mA
Operating Current (2)	I _{CC2}	V ⁺ =9V (Note1)	9.8	14.1	18.4	mA
Voltage Gain	G _V	V _I = 100kHz, 2V _{P-P} , V _O /V _I	- 0.6	- 0.1	+ 0.4	dB
Frequency Gain	G _F	V _I = 2V _{P-P} , V _O (10MHz)/V _O (100kHz)	- 1.0	0	+ 1.0	dB
Differential Gain	DG	V _I = 2V _{P-P} , Standard Staircase Signal	-	0.3	-	%
Differential Phase	DP	V _I = 2V _{P-P} , Standard Staircase Signal	-	0.3	-	deg
Output Offset Voltage	V _{OS}	(Note2)	-15	0	+15	mV
Crosstalk	CT	V _I = 2V _{P-P} , 4.43MHz, V _O /V _I	-	-75	-	dB
Switch Change Over Voltage	V _{CH}	All inside Switch ON	2.5	-	-	V
Switch Change Over Voltage	V _{CL}	All inside Switch OFF	-	-	1.0	V

(Note1) S1=S2=S3=S4=S5=S6=S7=1

(Note2) S1=S2=S3=S4=S5=S6=1, S7=1→2 Measure the output DC voltage difference



■ TEST CIRCUIT

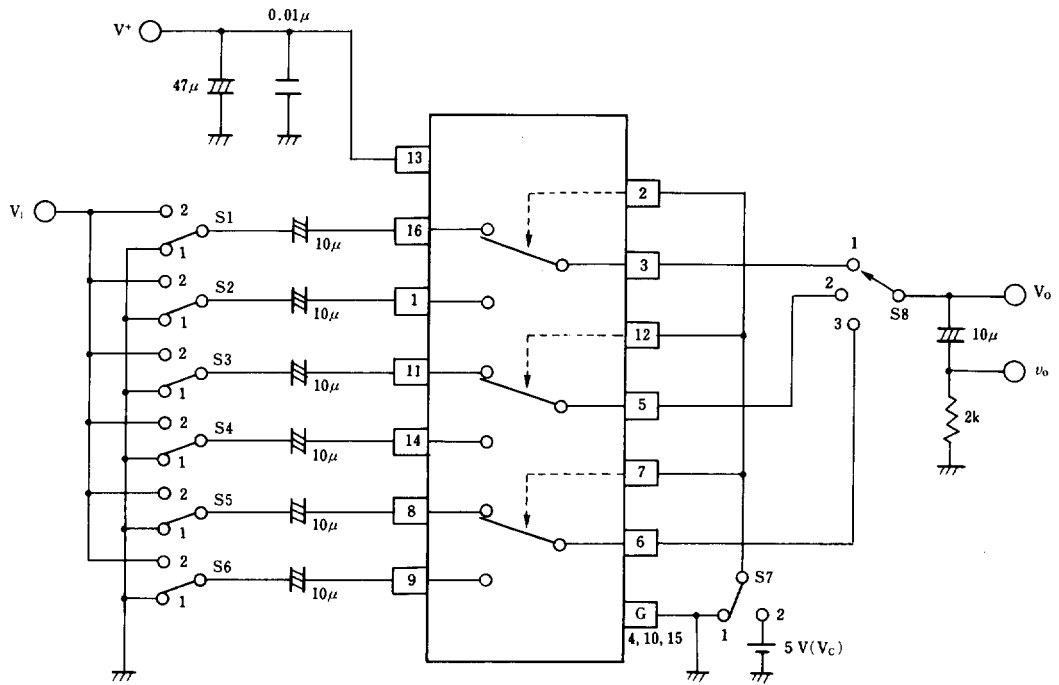

5

PARAMETER	S 1	S 2	S 3	S 4	S 5	S 6	S 7	S 8	TEST PART
I _{cc1}	1	1	1	1	1	1	1	1	V ⁺
I _{cc2}	1	1	1	1	1	1	1	1	V ⁺
G _{v1}	2	1	1	1	1	1	1	1	v ₀
G _{t1}	2	1	1	1	1	1	1	1	v ₀
DG ₁	2	1	1	1	1	1	1	1	v ₀
DP ₁	2	1	1	1	1	1	1	1	v ₀
CT 1	2	1	1	1	1	1	2	1	v ₀
CT 2	1	2	1	1	1	1	1	1	v ₀
CT 3	1	1	2	1	1	1	2	2	v ₀
CT 4	1	1	1	2	1	1	1	2	v ₀
CT 5	1	1	1	1	2	1	2	3	v ₀
CT 6	1	1	1	1	1	2	1	3	v ₀
V _{os1}	1	1	1	1	1	1	1/2	1	V ₀
V _{c1}	1/2	2/1	1	1	1	1	V _c	1	V _c
THD	2	1	1	1	1	1	1	1	v ₀



NJM2286

■ TERMINAL EXPLANATION

PIN No.	PIN NAME	VOLTAGE	INSIDE EQUIVALENT CIRCUIT
16 1 11 14 8 9	IN 1 A IN 1 B IN 2 A IN 2 B IN 3 A IN 3 B (Input)	1.5V	
2 12 7	CTL 1 CTL 2 CTL 3 (Switching)		
3 5 6	OUT 1 OUT 2 OUT 3 (Output)	0.8V	
13	V+	5V	
15 4 10	GND 1 GND 2 GND 3		

5



■ TYPICAL CHARACTERISTICS

Operating Current 1 vs. Temperature
($V^+ = 9V$)

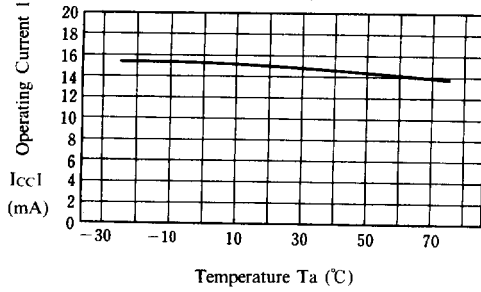

Operating Current vs. Operating Voltage
($T_a = 25^\circ C$)

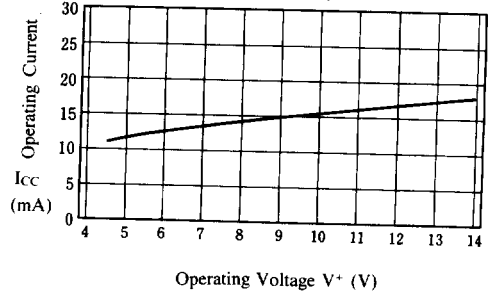

Voltage Gain 1 vs. Temperature
($V^+ = 5V$)

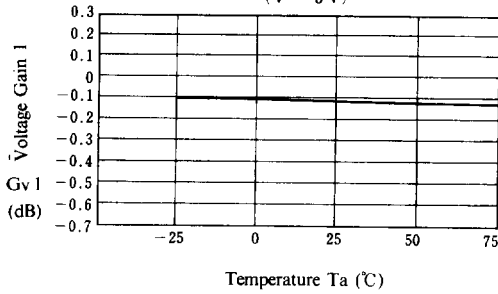

Frequency Gain 1 vs. Temperature
($V^+ = 5V$)

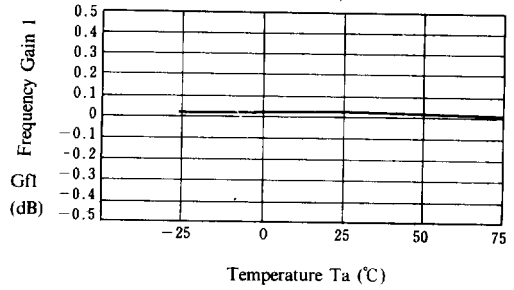

Differential Gain 1 vs. Temperature
($V^+ = 5V$)

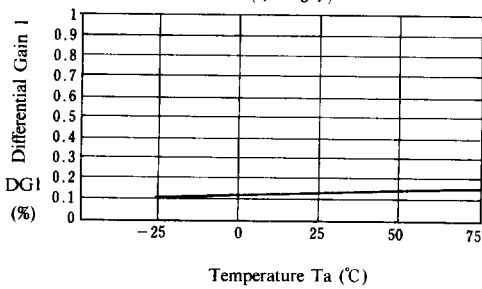

Differential Phase 1 vs. Temperature
($V^+ = 5V$)

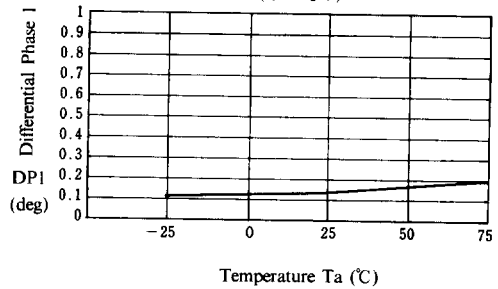

5



TYPICAL CHARACTERISTICS

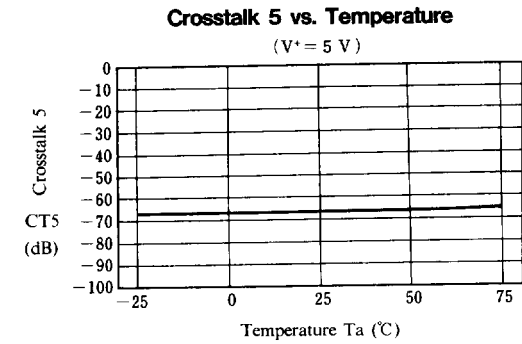
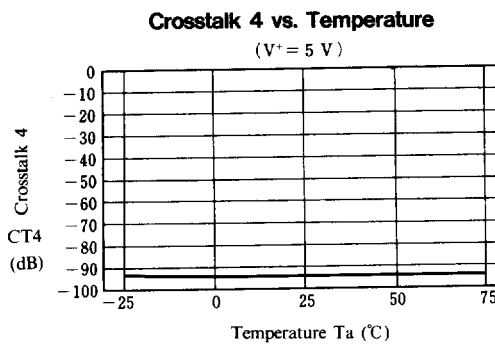
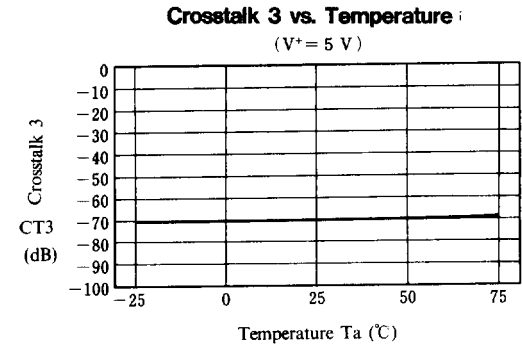
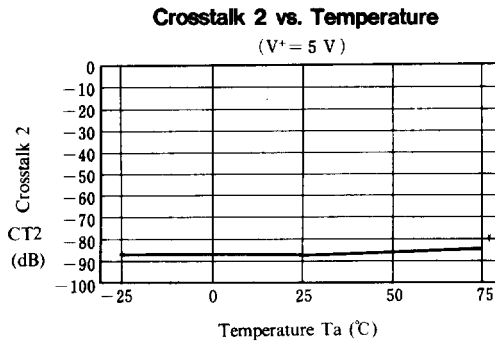
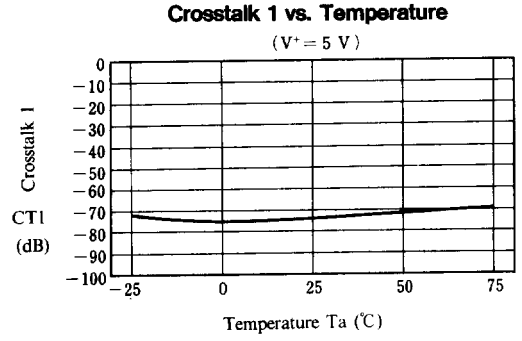
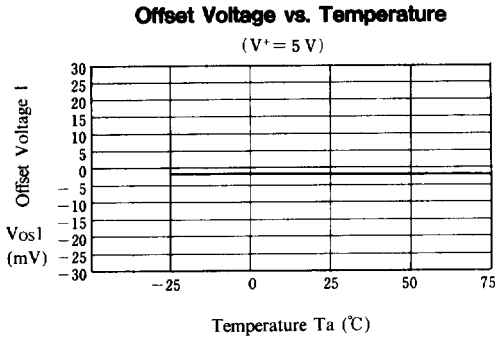

5



■ TYPICAL CHARACTERISTICS

Crosstalk 6 vs. Temperature

(V⁺ = 5 V)

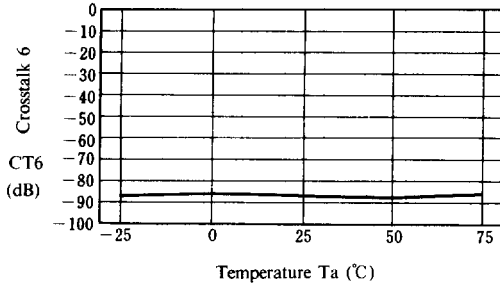

Switch Change Over 1 vs. Temperature

(V⁺ = 5 V)

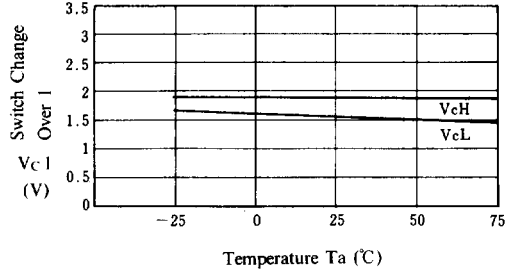

Supply Current 2 vs. Temperature

(V⁺ = 5 V)

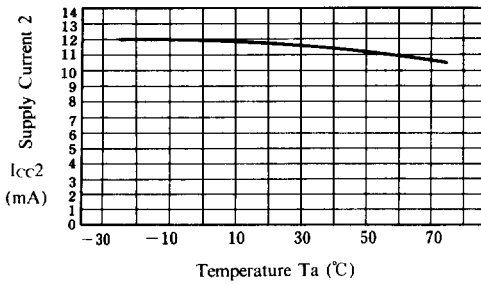

Voltage Gain 1 vs. Operating Voltage

(Ta = 25°C)

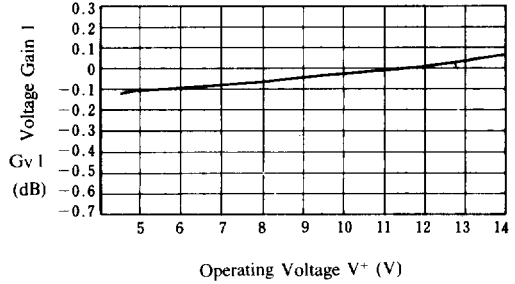

Frequency Gain 1 vs. Operating Voltage

(Ta = 25°C)

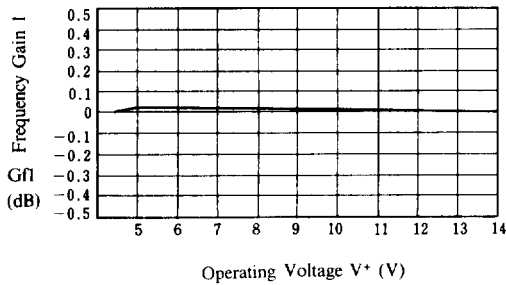

Differential Gain 1 vs. Operating Voltage

(Ta = 25°C)

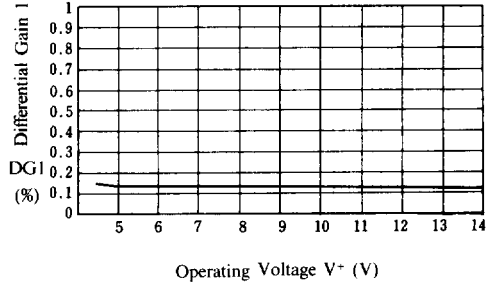

5



■ TYPICAL CHARACTERISTICS

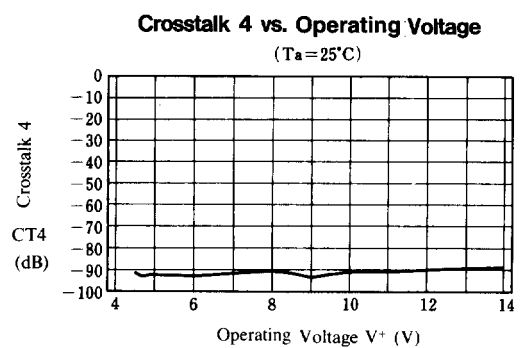
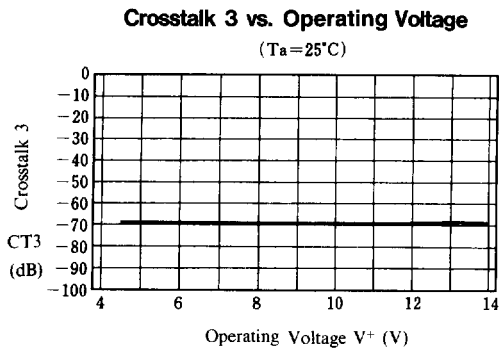
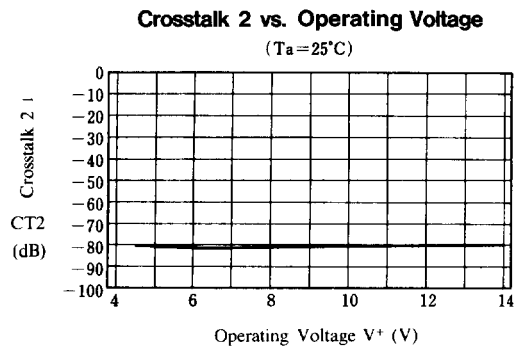
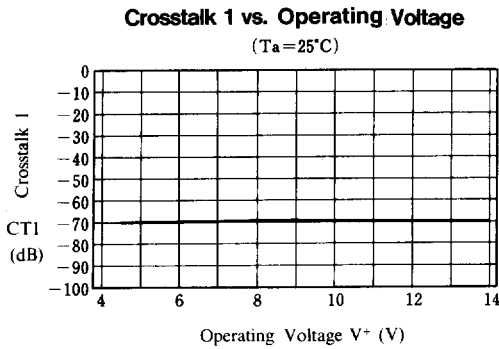
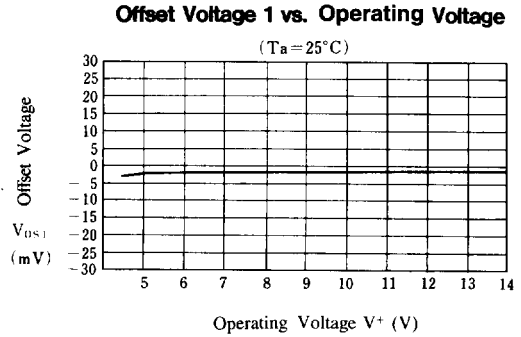
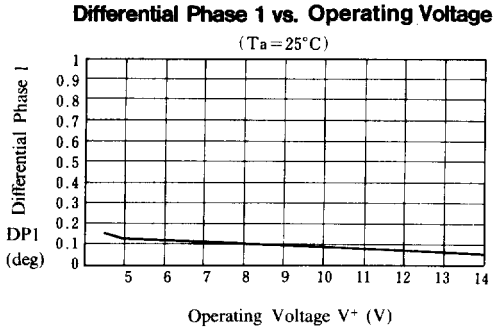



■ TYPICAL CHARACTERISTICS

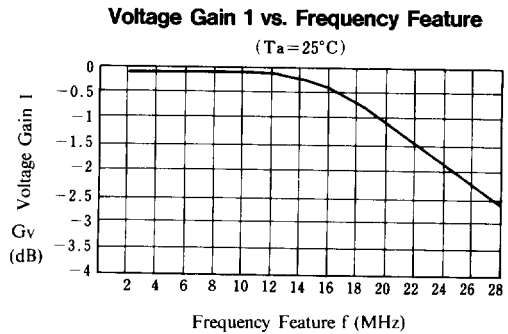
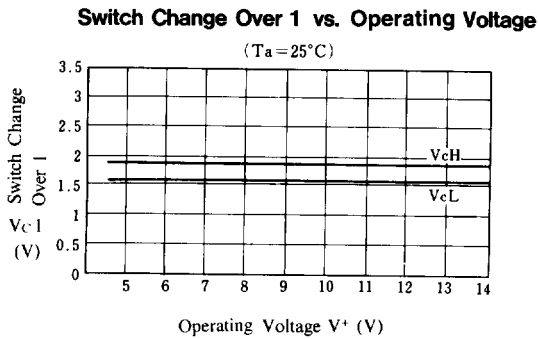
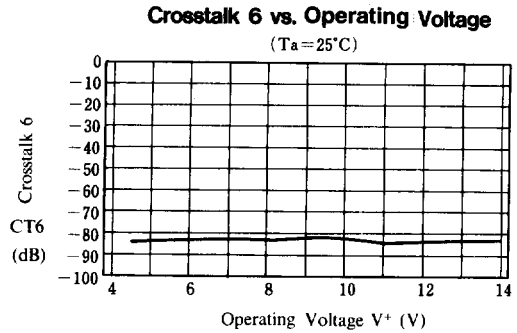
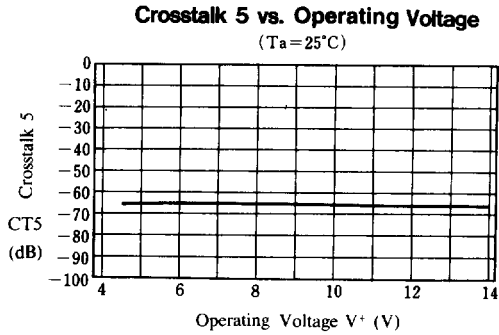

5

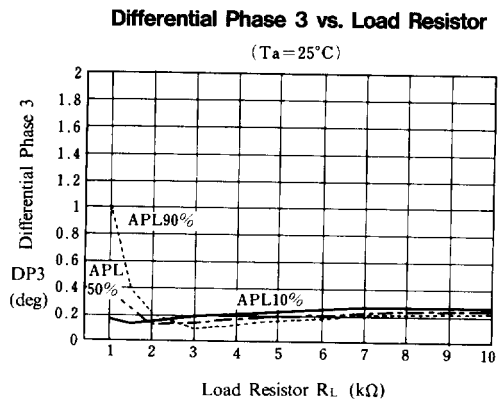
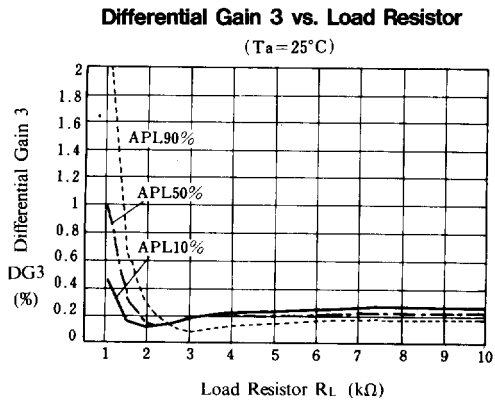



■ TYPICAL CHARACTERISTICS

