



FM IF IC FOR PAGERS

■ GENERAL DESCRIPTION

THE NJM2537 is a low power FM IF IC for pagers. It is capable of designing dual conversion pager system because of including a mixer circuit. Also it includes RSSI function, so that it is easy to design automatic gain control (AGC) which improves interference when strong signal is received.

■ PACKAGE OUTLINE

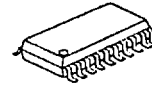

NJM2537V

■ FEATURES

- Low Operating Voltage 1.1~4.0V
- Low Operating Current 1.2mA typ. at $V^+=1.4V$
- RF Input Frequency 10~50MHz
- 2nd Mixer
- Package Outline SSOP20

■ PIN FUNCTION AND BLOCK DIAGRAM

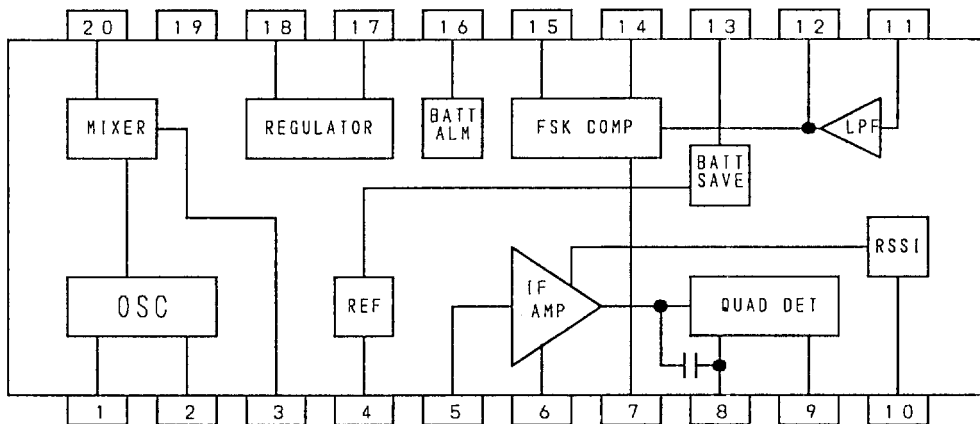

- | | |
|---------------|--------------|
| 1. OSC IN | 11. LPF IN |
| 2. OSC OUT | 12. LPF OUT |
| 3. MIXER OUT | 13. BS |
| 4. V^+ | 14. CHARGE |
| 5. IF IN | 15. FSK OUT |
| 6. DECOUPLING | 16. VALM |
| 7. FSK REF | 17. REG CONT |
| 8. QUAD IN | 18. REG OUT |
| 9. AF OUT | 19. GND |
| 10. RSSI | 20. MIXER IN |



NJM2537

■ MAXIMUM ABSOLUTE RATING

(Ta=25°C)

PARAMETER	SYMBOL	RATINGS	UNIT
Supply Voltage	Vcc	4.0	V
Power Dissipation	P _D	300	mW
Operating Temperature Range	Topr	-30~+85	°C
Storage Temperature Range	Tstg	-40~+125	°C

■ ELECTRICAL CHARACTERISTICS (V⁺=1.4V, f_c=21.7MHz, f_{IF}=455kHz, f_{mod}=600Hz, f_{dev}=±4kHz, Ta=25°C)

PARAMETER	SYMBOL	TEST CONDITION	MIN.	TYP.	MAX.	UNIT
No Signal Operating Current	I _{ccq}		-	1.2	1.5	mA
Battery Saving	I _{ccs}		-	0	5	μA
Operating Current						
Mixer Gain	GMIX	After Ceramic Filter	11	14.5	18	dB
Mixer Intercept Point	IP		-	103	-	dB μVEMF
Mixer Input Resistance	R _{inMIX}		-	5	-	kΩ
Mixer Output Resistance	R _{oMIX}		-	2	-	kΩ
IF Amplifier Input Resistance	R _{inIF}		-	2	-	kΩ
S/N 1	S/N1	MIXER Input, Vi=60dB μVEMF	-	63	-	dB
S/N 2	S/N2	IF Input, Vi=60dB μVEMF	-	63	-	dB
S/N 3	S/N3	IF Input, Vi=22dB μVEMF	-	25	-	dB
-3dB Limiting Sensitivity 1	LIM1	MIXER Input	-	12	17	dB μVEMF
-3dB Limiting Sensitivity 2	LIM2	IF Input	-	22	27	dB μVEMF
Demodulated Output Level	V _{od}	IF Input, Vi=60dB μVEMF	30	46	65	mVrms
AM Rejection Ratio	AMR	IF Input, Vi=60dB μVEMF, AM=30%	-	50	-	dB
Duty Ratio at Wave Shaped Output	DR	IF Input, Vi=60dB μVEMF	40	50	60	%
RSSI Output Voltage	V _{rssI}	IF Input, Vi=65dB μVEMF	0.48	0.62	0.76	V
RSSI Output Resistance	R _{rssI}		-	62	-	kΩ
Quick Charge/Discharge Current	I _{ch}	GND, 0.18V	40	70	115	μA
Alarm Detection Voltage	V _{alm}		1.05	1.10	1.15	V
Regulator Output Voltage	V _{reg}	RL=430Ω	0.95	1.00	1.05	V
Low Level Output Voltage of VALM Terminal	V _{almL}	IL=100 μA	-	0.1	0.4	V
High Level Leak Current of VALM Terminal	I _{almH}		-	0	2	μA
Low Level Output Voltage of FSK-OUT Terminal	V _{fskL}	IL=100 μA	-	0.1	0.4	V
High Level Leak Current of FSK-OUT Terminal	I _{fskH}		-	0	2	μA
Low Level Output Voltage of REG-OUT Terminal	V _{regL}	IL=100 μA	-	-	0.6	V



■ APPLICATION CIRCUIT

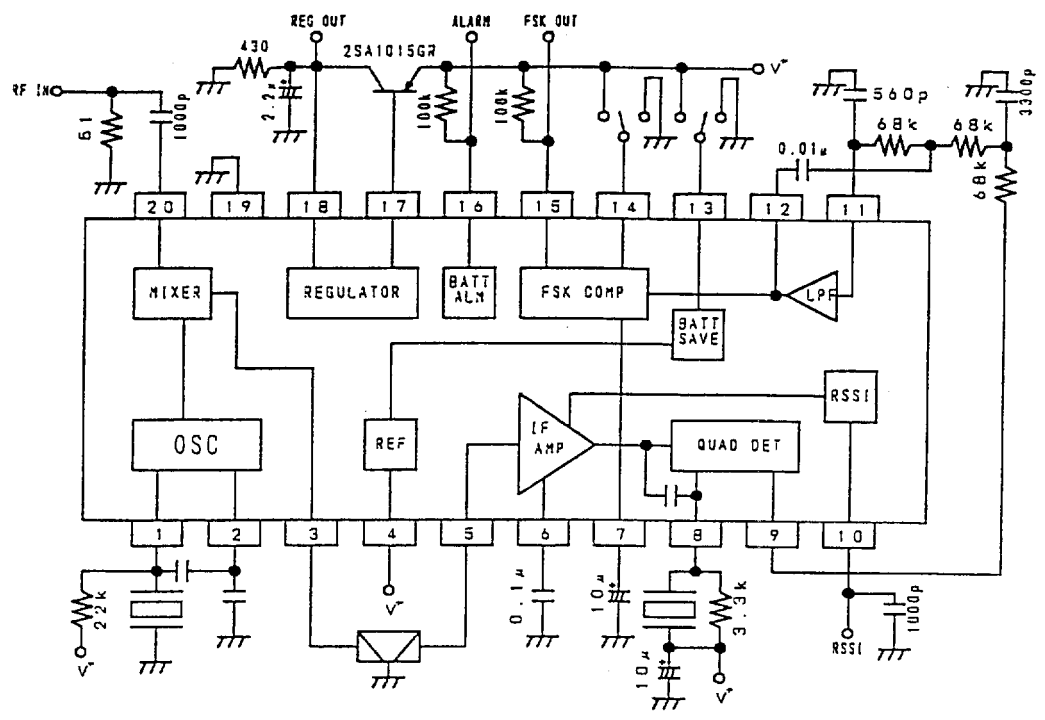



■ TERMINAL FUNCTION

PIN NO.	SYMBOL	PIN VOLTAGE (V)	FUNCTION	EQUIVALENT CIRCUIT
1	OSC IN	1.38	Local Oscillator Input. In case of using a crystal oscillator, it is connected.	
2	OSC OUT	0.68	Local Oscillator Output. In case of using an external oscillator, the external clock is input.	
20	MIX IN	0.8	Mixer input. Input resistance is 5kΩ typical.	
3	MIX OUT	0.7	Mixer output. Output resistance is 2kΩ typical.	
5	IF IN	1.38	Limiter amplifier input. Input resistance is 2kΩ typical.	
6	DEC	1.38	Decoupling for bias.	
8	QUAD IN	1.4	Input of quadrature detection circuit. A ceramic discriminator is connected.	
9	AF OUT	0.16	Demodulated signal output.	



■ TERMINAL FUNCTION

PIN NO.	SYMBOL	PIN VOLTAGE (V)	FUNCTION	EQUIVALENT CIRCUIT
10	RSSI	0	RSSI output.	
11	LPF IN	0.18	Input of a low pass filter. It is biased from AF-OUT (9pin) through an external RC filter.	
12	LPF OUT	0.18	Output of a low pass filter.	
7	FSK REF	0.18	Reference input of a wave shaping comparator. An external capacitor is connected.	
13	BS	—	Control of a battery saving circuit. Hi: active Lo: suspended	
14	CHARGE	—	Control of a quick charge/discharge circuit Hi: Its circuit turns ON Lo: Its circuit turns OFF	
15	FSK OUT	—	Output of a wave shaping circuit. The output signal is inverted against LPF output signal.	



■ TERMINAL FUNCTION

PIN NO.	SYMBOL	PIN VOLTAGE (V)	FUNCTION	EQUIVALENT CIRCUIT
16	VALM	0.1	Output of the alarm signal. When V^+ drops down to 1.1V, this output becomes high.	
17	REG CONT	0.6	Control of an external PNP transistor used for the regulator.	
18	REG OUT	1.0	Monitoring of the regulator.	
4	V^+	—	Power Supply.	—
19	GND	—	Ground	—



■ TYPICAL CHARACTERISTICS

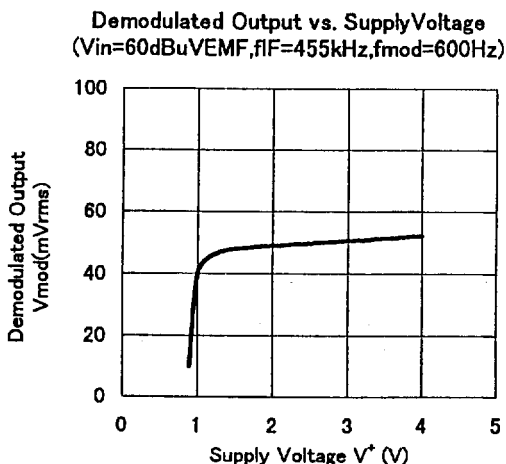
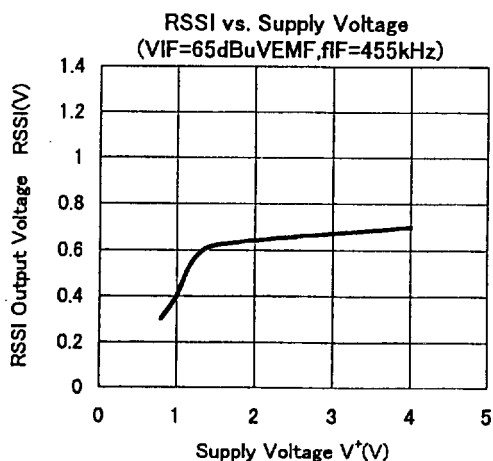
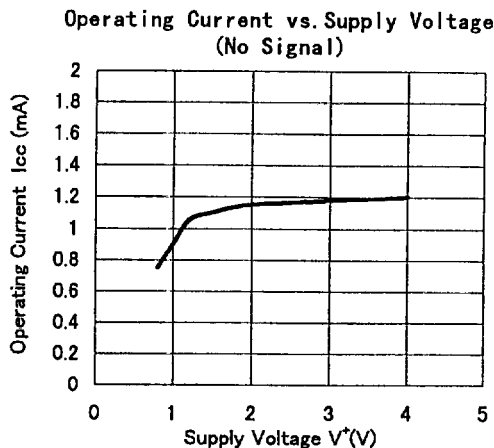
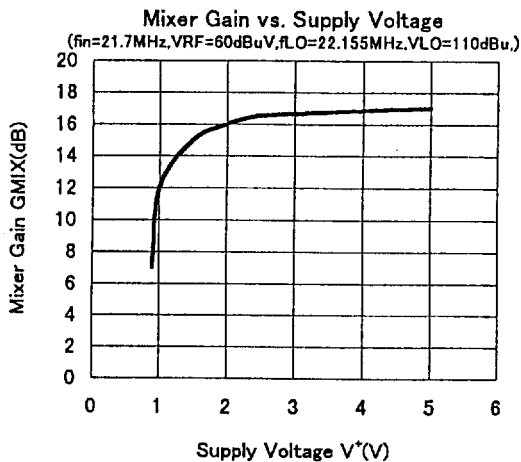
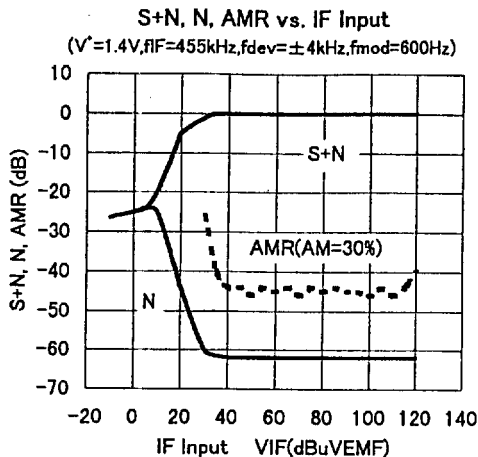
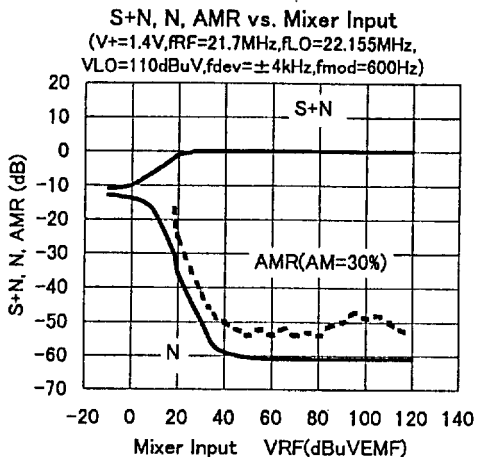



■ TYPICAL CHARACTERISTICS

Quick Charge Current vs. Supply Current
(12pin=0.18V)

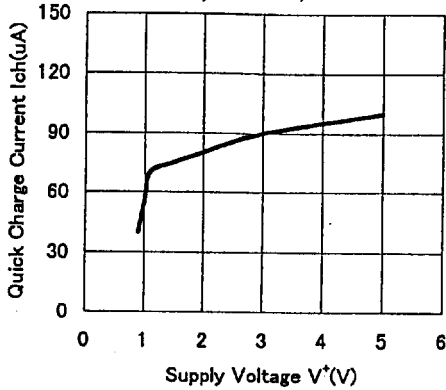

Operating Current vs. Temperature
($V_t=1.4V$)

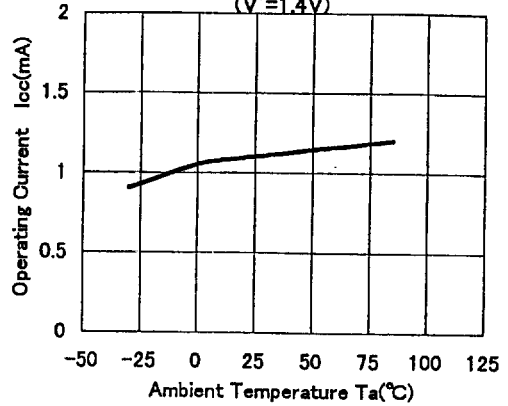

Battery Saving Operating Current vs. Temperature
($V_t=1.4V$)

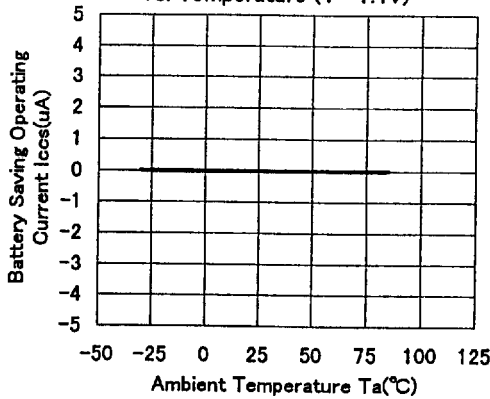

Quick Charge Current vs. Temperature
($V_t=1.4V, 12pin=0.18V$)

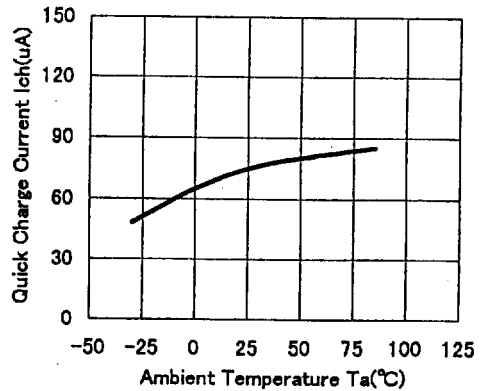

Mixer Gain vs. Temperature
($V_t=1.4V, f_{RF}=21.7MHz, V_{in}=60dBuV$)

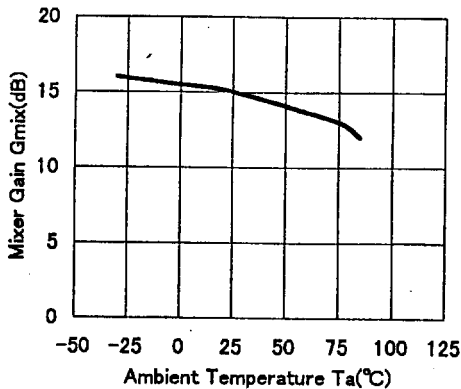

Demodulated Output vs. Temperature
($V_t=1.4V, f_F=455kHz, V_{in}=60dBuVEMF, f_{mod}=600Hz$)

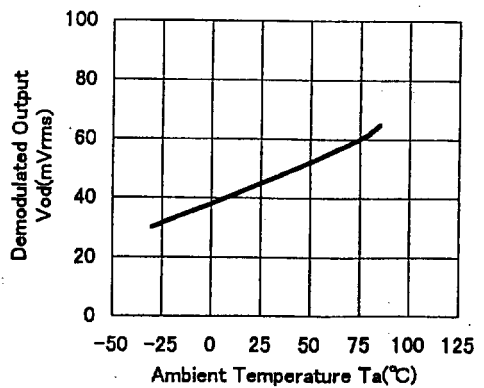

■ TYPICAL CHARACTERISTICS

