



## $\mu$ -POWER OPERATIONAL AMPLIFIER

### ■ GENERAL DESCRIPTION

The NJM4250 is extremely versatile programmable monolithic operational amplifiers. A single external master bias current setting resistor programs the input bias current, input offset current, quiescent power consumption, slew rate, input noise, and the gain-bandwidth product. The device is a truly general purpose operational amplifier.

### ■ PACKAGE OUTLINE

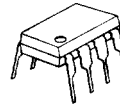

NJM4250D



NJM4250M



NJM4250V

### ■ FEATURES

- Operating Voltage ( $\pm 1V \sim \pm 18V$ )
- Low Operating Current (0.1mA max.)
- Programmable monolithic OP-Amp
- Very Low Power Consumption
- Package Outline DIP8, DMP8, SSOP8
- Bipolar Technology

### ■ PIN CONFIGURATION

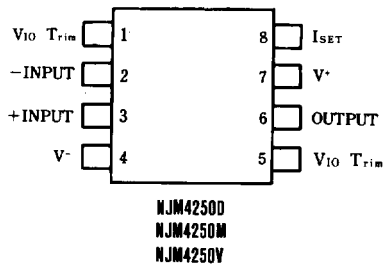

### ■ EQUIVALENT CIRCUIT (1/2 shown)

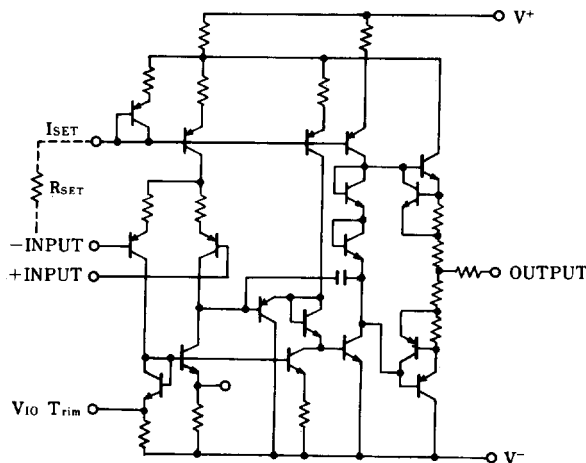



■ ABSOLUTE MAXIMUM RATINGS

(Ta=25°C)

PARAMETER	SYMBOL	RATINGS	UNIT
Supply Voltage	V <sup>+</sup> /V <sup>-</sup>	±18	V
Differential Input Voltage	V <sub>ID</sub>	±30	V
Input Voltage	V <sub>IC</sub>	±15 (note)	V
Power Dissipation	P <sub>D</sub>	(DIP8) 500	mW
		(DMP8) 300	mW
		(SSOP8) 250	mW
Operating Temperature Range	I <sub>SET</sub>	150	μA
Storage Temperature Range	T <sub>opr</sub>	-20~+75	°C
	T <sub>stg</sub>	-40~+125	°C

(note) For supply voltage less than ±15V, the absolute maximum input voltage is equal to the supply voltage.

■ ELECTRICAL CHARACTERISTICS

(Ta=25°C, V<sup>+</sup>/V<sup>-</sup>=±15V)

PARAMETER	SYMBOL	TEST CONDITION	I <sub>SET</sub> =1 μA		I <sub>SET</sub> =10 μA		UNIT
			MIN.	MAX.	MIN.	MAX.	
Input Offset Voltage 1	V <sub>IO 1</sub>	R <sub>S</sub> ≤ 100kΩ	—	5	—	6	mV
Input Offset Voltage 2	V <sub>IO 2</sub>	V <sup>+</sup> /V <sup>-</sup> = ±1.5V, R <sub>S</sub> ≤ 100kΩ	—	5	—	6	mV
Input Offset Current	I <sub>IO</sub>		—	6	—	20	nA
Input Bias Current 1	I <sub>B 1</sub>		—	10	—	75	nA
Input Bias Current 2	I <sub>B 2</sub>	V <sup>+</sup> /V <sup>-</sup> = ±1.5V	—	10	—	75	nA
Large Signal Voltage Gain 1	A <sub>v 1</sub>	V <sub>o</sub> = ±10V, R <sub>L</sub> ≥ 100kΩ	96	—	—	—	dB
Large Signal Voltage Gain 2	A <sub>v 2</sub>	V <sub>o</sub> = ±10V, R <sub>L</sub> ≥ 10kΩ	—	—	96	—	dB
Operating Current 1	I <sub>CC 1</sub>		—	11	—	100	μA
Operating Current 2	I <sub>CC 2</sub>	V <sup>+</sup> /V <sup>-</sup> = ±1.5V	—	8	—	90	μA
Input Common Mode Voltage Range 1	V <sub>ICM 1</sub>		±13.5	—	±13.5	—	V
Input Common Mode Voltage Range 2	V <sub>ICM 2</sub>	V <sup>+</sup> /V <sup>-</sup> = ±1.5V	±0.6	—	±0.6	—	V
Maximum Output Voltage Swing 1	V <sub>OM 1</sub>	R <sub>L</sub> ≥ 100kΩ	±12	—	—	—	V
Maximum Output Voltage Swing 2	V <sub>OM 2</sub>	V <sup>+</sup> /V <sup>-</sup> = ±1.5V, R <sub>L</sub> ≥ 100kΩ	±0.6	—	—	—	V
Maximum Output Voltage Swing 3	V <sub>OM 3</sub>	R <sub>L</sub> ≥ 10kΩ	—	—	±12	—	V
Maximum Output Voltage Swing 4	V <sub>OM 4</sub>	V <sup>+</sup> /V <sup>-</sup> = ±1.5V, R <sub>L</sub> ≥ 10kΩ	—	—	±0.6	—	V
Common Mode Rejection Ratio	CMR	R <sub>S</sub> ≤ 10kΩ	70	—	70	—	dB
Supply Voltage Rejection Ratio	SVR	R <sub>S</sub> ≤ 10kΩ	74	—	74	—	dB

■ TYPICAL APPLICATION (I<sub>SET</sub>, V<sub>IO</sub> Adjustment)

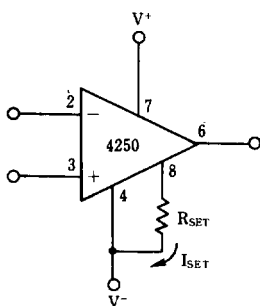

$$I_{SET} = \frac{V^+ + |V^-| - 0.5}{R_{SET}}$$

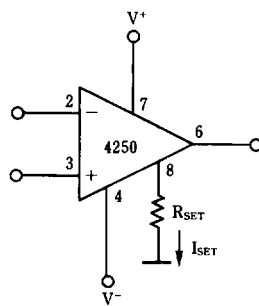

$$I_{SET} = \frac{V^+ - 0.5}{R_{SET}}$$

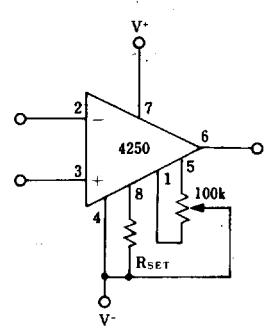

Offset Adjustment



## ■ TYPICAL CHARACTERISTICS

**Input Bias Current vs. Set Current**  
( $T_a = 25^\circ\text{C}$ )

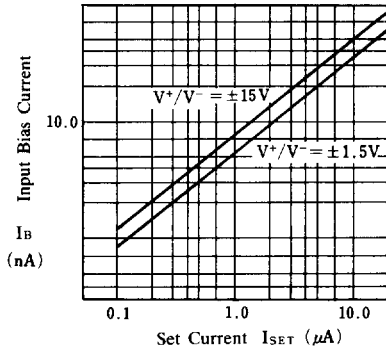

**Input Bias Current vs. Temperature**

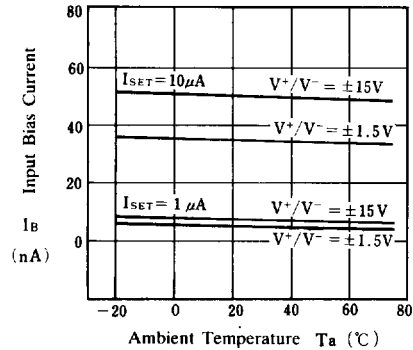

**Input Offset Current vs. Ambient Temperature**  
( $I_{SET} = 10\mu\text{A}$ ,  $\pm 1.5\text{V} \leq V^+/V^- \leq \pm 15\text{V}$ )

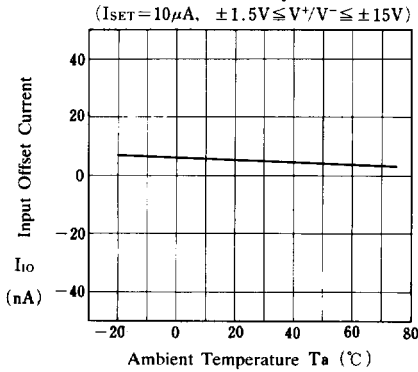

**Input Offset Voltage vs. Set Current**  
( $\pm 1.5\text{V} \leq V^+/V^- \leq \pm 15\text{V}$ ,  $T_a = 25^\circ\text{C}$ )

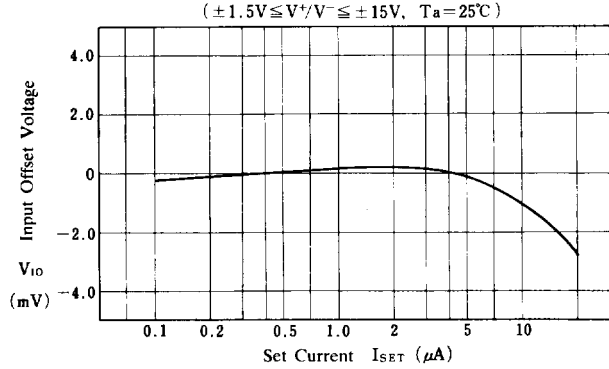

**Input Offset Voltage vs. Ambient Temperature**  
( $I_{SET} = 10\mu\text{A}$ )

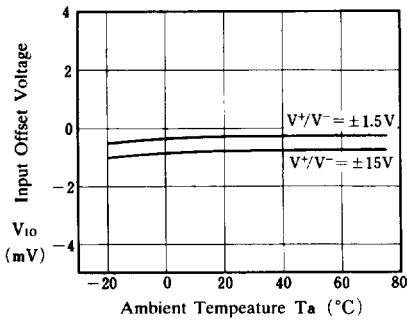

**Maximum Output Voltage Swing vs. Output Current**  
( $I_{SET} = 10\mu\text{A}$ ,  $T_a = 25^\circ\text{C}$ )

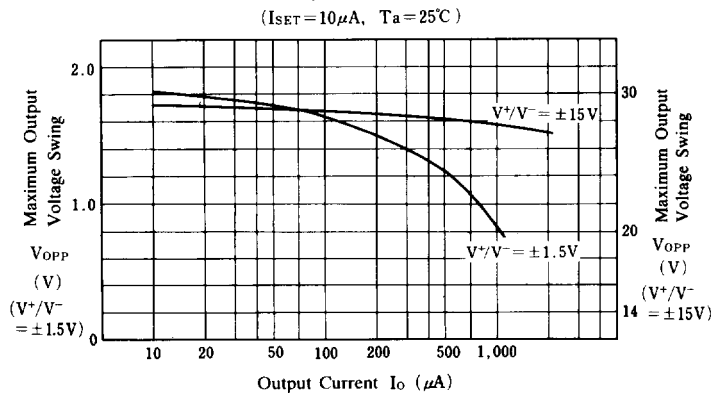



■ TYPICAL CHARACTERISTICS

**Maximum Output Voltage Swing vs. Operating Voltage**  
 (  $1\mu A \leq I_{SET} \leq 10\mu A$ ,  $R_L = 10k\Omega$ ,  $T_a = 25^\circ C$  )

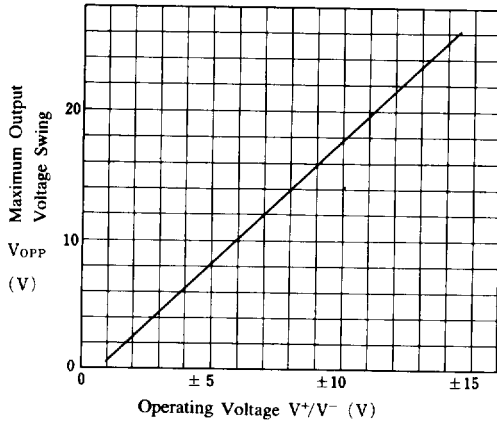

**Operating Current vs. Set Current**  
 (  $T_a = 25^\circ C$  )

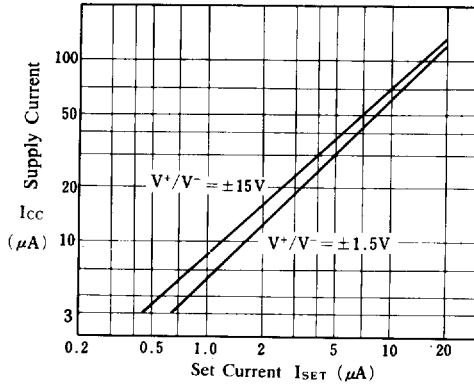

**Operating Current vs. Ambient Temperature**

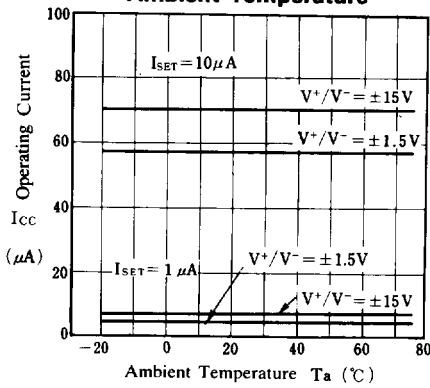

**Open Loop Voltage Gain vs. Set Current**  
 (  $R_L = 10k\Omega$ ,  $T_a = 25^\circ C$  )

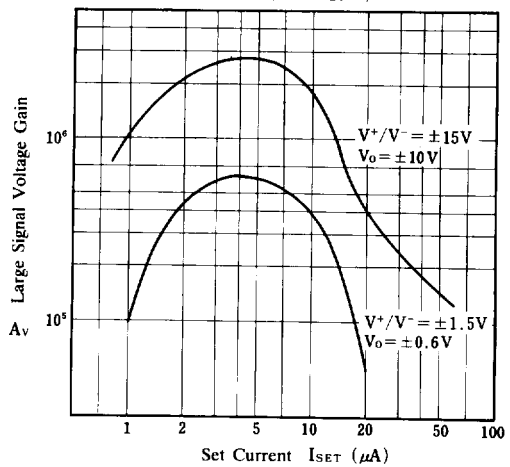



## ■ TYPICAL CHARACTERISTICS

**Gain Bandwidth Product vs. Set Current**  
( $T_a = 25^\circ\text{C}$ )

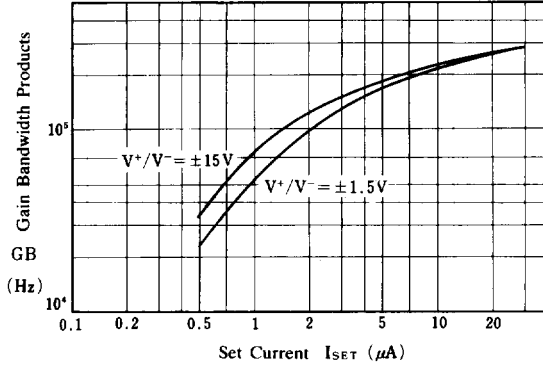

**Slew Rate vs. Set Current**  
( $R_L = 10\text{k}\Omega$ ,  $T_a = 25^\circ\text{C}$ )

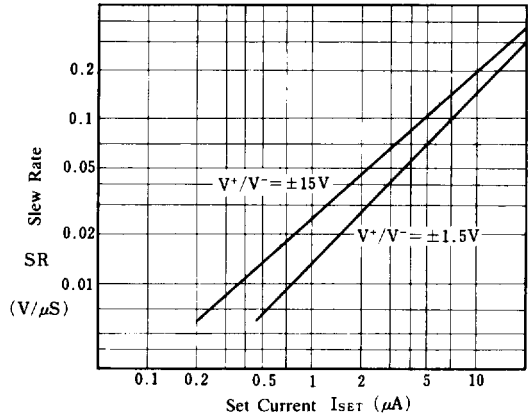

4

**Phase Margin vs. Set Current**

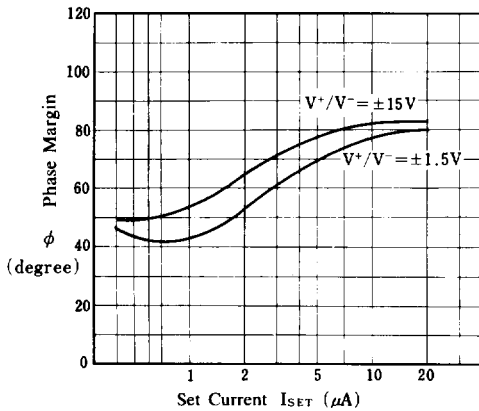

## ■ TYPICAL APPLICATIONS

500nW 10times Inverting Amplifier

