

SINGLE CHIP DIGITAL DELAY IC

■ GENERAL DESCRIPTION

NJU9702 is a single chip digital delay LSI designed for Dolby Prologic or other types surround processor.

It consists of 16k SRAM, input/output filter, A/D D/A converters and control logic.

The A/D and D/A converter is using a ADM (Adaptive Delta Modulation) method. Consequently, it is realized low noise and low distortion.

The delay time can select from 64 mode of 0.5ms to 32.8ms in 0.5ms step, according to the application.

Furthermore, the NJU9702 has a sleep mode, mute function, and power on initialization function which perform low current consumption in the sleep mode, muting on/off control and power on initialization.

■ PACKAGE OUTLINE

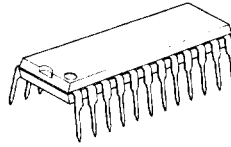

NJU9702D

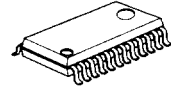

NJU9702S

■ FEATURES

- ADM (Adaptive Delta Modulation) Method A/D and D/A Converter
- Low Noise and Low Distortion (No=95[dBV] TYP., THD=0.2[%] TYP.)
- 64 Delay Time Modes From 0.5ms To 32.8ms In 0.5ms step
- Low Current Consumption In Sleep Mode
- Input/Output Filter Built-in (Required External CR)
- A/D, D/A Converter Built-in (Required External CR)
- 16K SRAM (Internal)
- Power on initialization
- Oscillation Circuit
- Package Outline
- C-MOS Technology

DIP24, SOP24

■ PIN CONFIGURATION

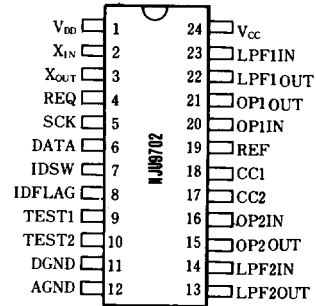

■ BLOCK DIAGRAM

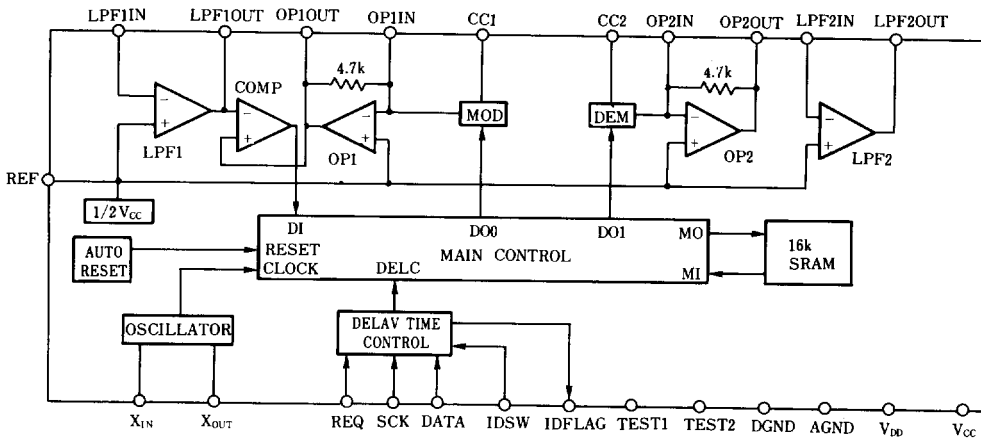

4



■ TERMINAL DESCRIPTION

NO.	SYMBOL	FUNCTIONS	
1	V _{DD}	Voltage Supply for Digital Block V _{DD} =5[V]	
11	DGND	Digital GND DGND=0[V]	
24	V _{CC}	Voltage Supply for Analog Block V _{CC} =5[V]	
12	AGND	Analog GND AGND=0[V]	
19	REF	Analog Reference Voltage REF=1/2 · V _{CC}	
2	X _{IN}	Oscillator Input Terminal	
3	X _{OUT}	Oscillator Output Terminal	Connects to 2MHz ceramic Oscillator
4	REQ	Data Request Input Terminal	
5	SCK	Serial Data Shift Clock Input Terminal	
6	DATA	Serial Data Input Terminal	
7	IDSW	ID Switch (ID Code When Connect to the Common Bus)	
8	IDFLAG	ID Flag (Data Input Confirmation and Serial Data Output)	
18	CC1	Current Control 1 Modulator	ADM Controller
17	CC2	Current Control 2 Demodulator	
9, 10	TEST1, 2	Test Terminal (Normally Connects to the GND)	
23	LPF1IN	Lowpass Filter 1 Input	Input Side
22	LPF1OUT	Lowpass Filter 1 Output	
14	LPF2IN	Lowpass Filter 2 Input	Output Side
13	LPF2OUT	Lowpass Filter 2 Output	
20	OP1IN	OP-AMP 1 Input	Input Side
21	OP1OUT	OP-AMP 1 Output	
16	OP2IN	OP-AMP 2 Input	Output Side
15	OP2OUT	OP-AMP 2 Output	



■ FUNCTION DESCRIPTION

The sampling frequency (fs) is 500KHz when master clock frequency is 2MHz.

1)Data Format and Setting

The delay time is set by serial data.

The serial data is written into the NJU9702 synchronized by falling edge of shift clock (SCK) and the last 12 bit is effective before the data request (REQ) rising edge.

The time chart of serial data input is shown as follows.

In order to avoid the shock noise output at the delay time setting, mute function using is recommended.

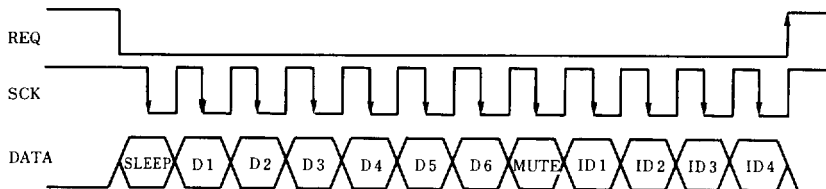

(note1)

When the corresponding DATA of ID code (refer 5) input to the NJU9702 during the REQ signal is " High", the DATA changed because of the NJU9702 always loading the latest 12-bit data.

Therefore following three operation methods are required when serial data input.

- a)Fix the DATA terminal to " High" or "Low" except data setting period.
- b)Fix the REQ terminal to "Low" except data setting period.
- c)Fix the SCK terminal to " High" or "Low" after 12-bit data input.

(note2)

To use the mute after setting the delay time to avoided the shock noise.

2)Sleep Mode Setting

The sleep mode can be set by writing the code "1" (H level) to the Sleep bit of the serial data.

The sleep mode performs ① output muting, ② stop the internal clock, ③ stop the memory operation and put a low current consumption mode. Normally, this Sleep bit must be "0" (L level).

In order to avoid the shock noise output when the sleep mode released, mute function using is recommended.

SLEEP	MODE	FUNCTIONS
0	NORMAL	Normal operation
1	SLEEP	①Output Muting ② Stop the Internal Clock ③ Stop the Memory Operation



3) Delay Time Setting

64 kind of delay time from 0.5ms to 32.8ms in 0.5ms is set by D1 to D6 of the serial data.

D6	D5	D4	D3	D2	D1	Delay T.	
0	0	0	0	0	0	0.5	
				0	1	1.0	
				1	0	1.5	
				1	1	2.0	
			1	0	0	2.6	
				1	1	3.1	
				0	0	3.6	
				1	1	4.1	
		1	0	0	0	0	4.6
					1	1	5.1
				1	0	0	5.6
					1	1	6.1
			1	0	0	0	6.7
					1	1	7.2
				1	0	0	7.7
					1	1	8.2
		1	0	0	0	0	8.7
					1	1	9.2
				1	0	0	9.7
					1	1	10.2
			1	0	0	0	10.8
					1	1	11.3
				1	0	0	11.8
					1	1	12.3
		1	0	0	0	0	12.8
					1	1	13.3
				1	0	0	13.8
					1	1	14.3
			1	0	0	0	14.8
					1	1	15.4
				1	0	0	15.9
					1	1	16.4

D6	D5	D4	D3	D2	D1	Delay T.	
1	0	0	0	0	0	16.9	
				0	1	17.4	
				1	0	17.9	
				1	1	18.4	
			1	0	0	18.9	
				1	1	19.5	
				0	0	20.0	
				1	1	20.5	
		1	0	0	0	0	21.0
					1	1	21.5
				1	0	0	22.0
					1	1	22.5
			1	0	0	0	23.0
					1	1	23.6
				1	0	0	24.1
					1	1	24.6
		1	0	0	0	0	25.1
					1	1	25.6
				1	0	0	26.1
					1	1	26.6
			1	0	0	0	27.1
					1	1	27.6
				1	0	0	28.2
					1	1	28.7
		1	0	0	0	0	29.2
					1	1	29.7
				1	0	0	30.2
					1	1	30.7
			1	0	0	0	31.2
					1	1	31.7
				1	0	0	32.3
					1	1	32.8

4



4)Mute Setting

The mute mode can be set by writing the code "1" (H level) to the Mute bit of the serial data. Normally, this Mute bit must be "0" (L level).

MUTE	MODE	FUNCTIONS
0	NORMAL	Normal operation
1	SLEEP	Output Muting

5)ID Code Setting

The access from the controller (CPU) is recognized the ID code input. It is useful when the NJU9702 connect the common bus together with other LSI (s). The IDSW can select the prefixed ID code. If the other LSI using the ID code system and setting the same code already, please select other code by using this SW (IDSW).

CONDITIONS	CODE SELECTION TERM.	ID CODE			
	IDSW	ID1	ID2	ID3	ID4
1	0	0	0	1	0
2	1	0	0	1	1

(note) ID code input except mentioned above, the NJU9702 can not be receive any data. In this case, the NJU9702 still keeping the condition input before.

4

6)IDFLAG

IDFLAG is terminal to check the setting of delay time and the setting conditions.

When the serial data is received by the NJU9702, the IDFLAG terminal output "H" level for controller (CPU)'s confirmation.

After serial data writing, except the ID code (Sleep, D1 to D6, and Mute) can read out for checking. When the read out, ① set the "L" level of the request signal (REQ), ② input the clock signal are required. The data is output synchronized by the rising edge of the clock signal. The ID code can not read out even if over 8 clock input.

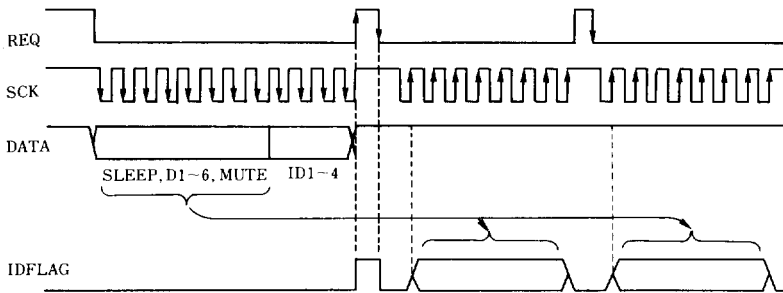



7)Reset Function

NJU9702 performs power-on-initialization when turn on the power. After 120ms passed the turn at the condition of $V_{CC}=5V$, Capacitor connecting to the REF terminal= $4.7 \mu F$, it is released automatically. The 20.0ms delay time is set by the power-on-initialization.

The reset period of NJU9702 depends on an on-chip resistance "R" and a capacitor connected REF terminal. Next expression can compute the reset time.

$$\text{Reset Time} = 2.5 \times C (\mu F)$$

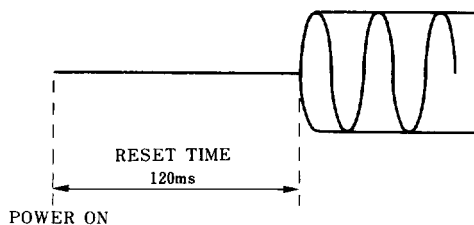

Condition : $V_{CC}=5V$, $C=4.7 \mu F$ (REF terminal)

(REMARKS)

The NJU9702 needs to work a MUTE function for interruption that shock noise occurs when RESET is released.

The NJU9702 needs to supply a power to V_{DD} in advance or at the mean time with other power source V_{CC} . If a power supplying sequence is not performed correctly, then power-on-initialization dose not work correctly.



■ ABSOLUTE MAXIMUM RATINGS

(Ta=25°C)

PARAMETER	SYMBOL	RATINGS	UNIT
Supply Voltage	V _{DD}	6.5	V
	V _{CC}	6.5	V
Operating Current	I _{CC}	100	mA
Power Dissipation	P _D	500	mV
Operating Temperature Range	T _{opr}	-20 ~ +75	°C
Storage Temperature Range	T _{stg}	-40 ~ +125	°C

(note) V_{DD} should be rise up before V_{CC} or same time. Otherwise power-on-initialization may not be operate correctly.

■ RECOMMENDED OPERATING CONDITIONS

(V^{*}=5V, Ta=25°C)

PARAMETER	SYMBOL	CONDITIONS	MIN.	TYP.	MAX.	UNIT
Operating Voltage	V _{DD}		4.5	5.0	5.5	V
	V _{CC}		4.5	5.0	5.5	V
Clock Frequency	f _{ck}			2.0		MHz
Input Voltage "H"	V _{IH}		0.7V _{DD}		V _{DD}	V
Input Voltage "L"	V _{IL}		0	-	0.3V _{DD}	V
Serial Clock	f _{sck}		-	-	4.0	MHz

4

■ ELECTRICAL CHARACTERISTICS

(V_{DD}=V_{CC}=5V, f=1kHz, V_O=200mVrms, Ta=25°C)

PARAMETER	SYMBOL	TEST CONDITIONS	MIN.	TYP.	MAX.	UNIT
Operating Current	I _{CC}	No Signal	-	16	35	mA
Voltage Gain	G _v	R _L =47KΩ	-3.5	-0.5	2.5	dB
Max. Output Voltage	V _{Omax}	THD=10%	0.7	1	-	Vrms
Output Distortion	THD	30kHz LPF	-	0.2	1.0	%
Output Noise Voltage	N _O	DIN-AUDIO	-	-95	-75	dBV
Supply Voltage Rejc. Ratio	SVRR	V _{CC} =20dBV, f=100Hz	-	-40	-25	dB
Frequency Characteristics	f	-3dB, V _O =100mVrms	-	7	-	kHz



■ SERIAL DATA TIMING

PARAMETER	SYMBOL	MIN.	TYP.	MAX.	UNIT
SCK Clock Width	t1	250	—	—	ns
SCK Duty	ds	40	50	60	%
Data Set-up Time	t2	100	t1/2	—	ns
Data Hold Time	t3	100	t1/2	—	ns
REQ Hold Time	t4	100	—	—	ns
REQ "H" Pulse Width	t5	100	—	—	ns
SCK Set-up Time	t6	100	—	—	ns

■ TIMING CHART

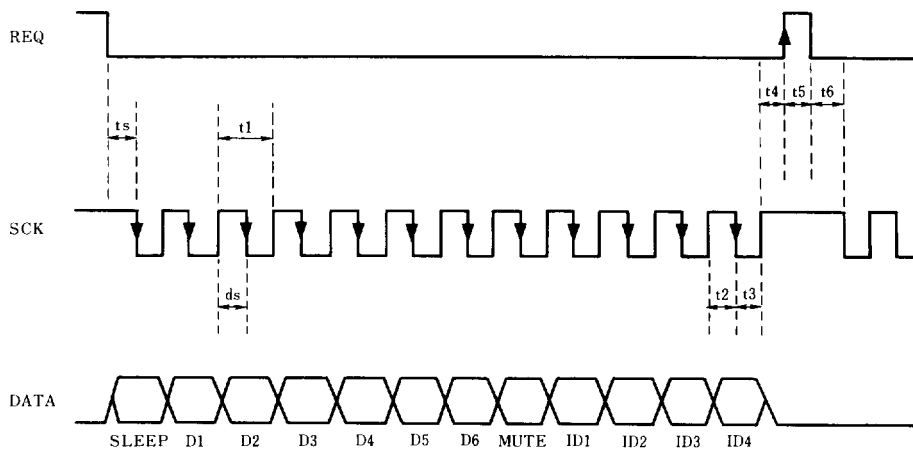

4



■ APPLICATION CIRCUIT(1) (Combined with NJM2177)

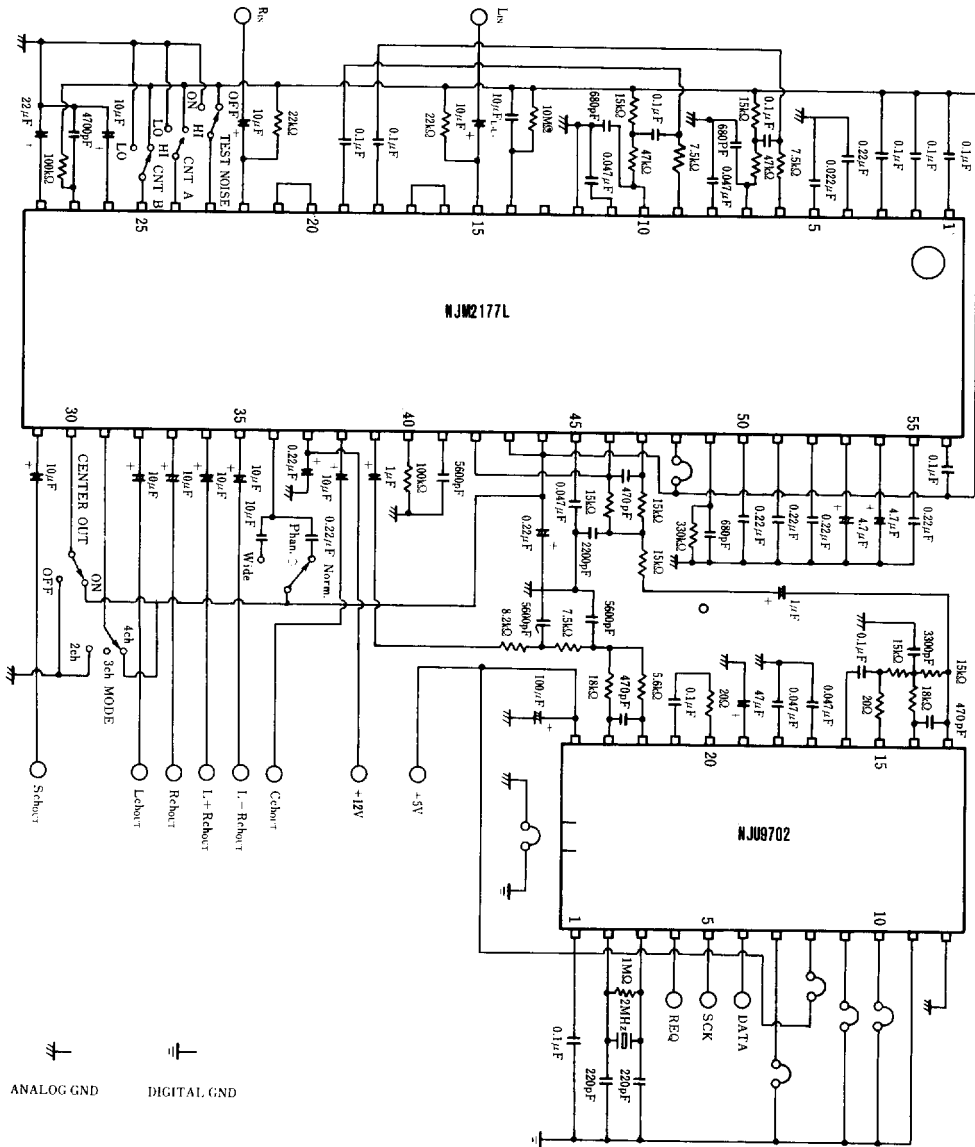

4



■ APPLICATION CIRCUIT(2) (Combined with NJW1102)

4

